

SMART
SENSOR
BUSINESS

MA 238i

Fieldbus Gateway – EtherCAT

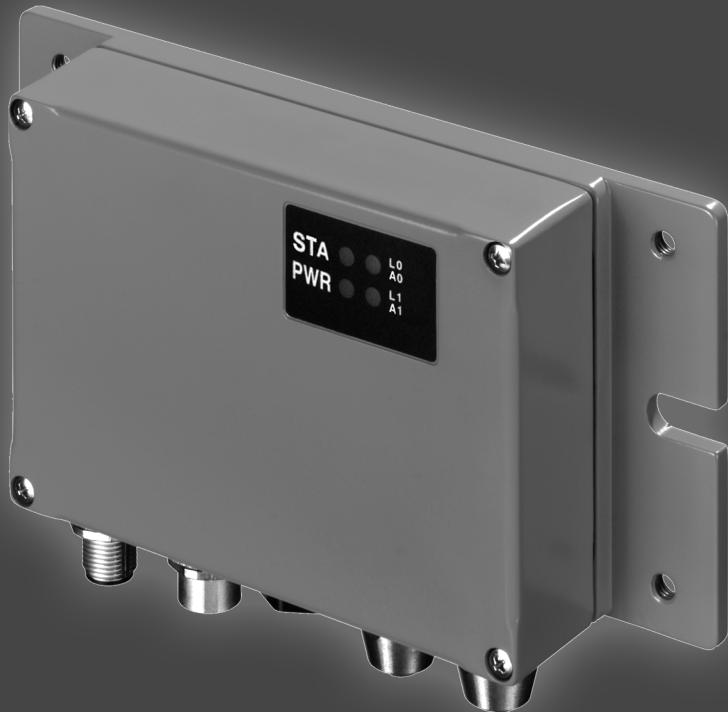

en 04-2017/01_50120383
We reserve the right to
make technical changes

© 2017

Leuze electronic GmbH + Co. KG

In der Braike 1

D-73277 Owen / Germany

Phone: +49 7021 573-0

Fax: +49 7021 573-199

<http://www.leuze.com>

info@leuze.com

1	General information	5
1.1	Explanation of symbols	5
1.2	Declaration of Conformity	5
1.3	Description of functions	6
1.4	Definition of terms	7
2	Safety	8
2.1	Intended use	8
2.2	Foreseeable misuse	8
2.3	Competent persons	9
2.4	Disclaimer	9
3	Fast commissioning / operating principle	10
3.1	Mounting	10
3.2	Device arrangement and selection of the mounting location	10
3.3	Electrical connection	10
3.3.1	Connecting the Leuze device	11
3.3.2	Connecting the power supply and the bus cable	11
3.4	Starting the device	11
3.5	MA 238 <i>i</i> on the EtherCat	12
3.5.1	Device description file	12
3.5.2	Device profile	12
3.5.3	Starting up the MA 238 <i>i</i> in the EtherCAT system	12
4	Device description	13
4.1	General Information to the connector units	13
4.2	Characteristics of the connector units	13
4.3	Device construction	14
4.4	Operating modes	15
4.5	Fieldbus systems	16
4.5.1	EtherCAT	16
5	Specifications	18
5.1	General specifications	18
5.2	Dimensioned drawings	19
5.3	Type overview	20

6	Installation and mounting	21
6.1	Storage, transportation	21
6.2	Mounting	22
6.3	Device arrangement	23
6.3.1	Selecting a mounting location	23
6.4	Cleaning	23
7	Electrical connection	24
7.1	Safety notices for the electrical connection	24
7.2	Electrical connection	25
7.2.1	PWR IN – voltage supply / switching input/output	25
7.2.2	PWR OUT switching input/output	27
7.3	BUS IN	27
7.4	BUS OUT	29
7.5	Device interfaces	30
7.5.1	RS 232 device interface (accessible after opening the device, internal)	30
7.5.2	Service interface (internal)	31
7.6	EtherCAT wiring	32
7.7	Cable lengths and shielding	32
8	Status displays and operational controls	33
8.1	LED status indicators	33
8.1.1	LED indicators on the circuit board	33
8.1.2	LED indicators on the housing	34
8.2	Internal interfaces and operational controls	35
8.2.1	Overview of operational controls of the	35
8.2.2	Connector X30 ... connectors	37
8.2.3	RS 232 service interface – X33	37
8.2.4	S10 service switch	37
8.2.5	Rotary switch S4 for device selection	38
9	Configuration	39
9.1	Connecting the service interface	40
9.2	Reading out information in Service mode	40
10	Telegram	43
10.1	Structure of the fieldbus telegram	43
10.2	Description of the input bytes (status bytes)	44

10.2.1	Structure and meaning of the input bytes (status bytes)	44
10.2.2	Detailed description of the bits (input byte 0)	45
10.2.3	Detailed description of the bits (input byte 1)	47
10.3	Description of the output bytes (control bytes)	47
10.3.1	Structure and meaning of the output bytes (control bytes)	47
10.3.2	Detailed description of the bits (output byte 0)	48
10.3.3	Detailed description of the bits (output byte 1)	49
10.4	RESET function / deleting memory	50
11	Modes	51
11.1	Functionality of the data exchange	51
11.1.1	Reading slave data in Collective mode (gateway -> PLC)	52
11.1.2	Writing slave data in Collective mode (PLC -> gateway)	52
11.1.3	Command mode	55
12	Commissioning and configuration	58
12.1	Measures to be performed prior to the initial commissioning	58
12.1.1	Connecting the power supply and the bus cable	59
12.2	Starting the device	59
12.3	MA 238 <i>i</i> in the EtherCAT system	59
12.4	Starting the MA 238 <i>i</i> in the EtherCAT system	59
12.5	CANopen over EtherCAT	60
12.5.1	Device profile	60
12.5.2	Device description file	60
12.5.3	Object index	62
12.6	Setting the read parameters on the Leuze device	66
12.6.1	Specific feature for the use of hand-held scanners (bar code and 2D devices, combi devices with RFID)	67
12.6.2	Specific features in the operation of an RFM/RFI	68
13	Diagnostics and troubleshooting	69
13.1	General causes of errors	69
13.2	Interface errors	70
14	Type overview and accessories	71
14.1	Part number code	71
14.2	Type overview	71
14.3	Accessory connectors	71
14.4	Accessory ready-made cables for voltage supply	72

14.4.1	Contact assignment of PWR connection cable	72
14.4.2	Specifications of the cables for voltage supply	72
14.4.3	Order codes of the cables for voltage supply	73
14.5	Accessory ready-made cables for bus connection	73
14.5.1	General information	73
14.5.2	M12 contact assignments-Ethernet connection cable KB ET.....	73
14.5.3	Technical data M12 Ethernet connection cable KB ET.....	74
14.5.4	Order code M12 Ethernet connection cable KB ET.....	74
14.6	Accessory ready-made cables for connecting Leuze Ident devices	75
14.6.1	Order codes for the device connection cables	75
14.6.2	Contact assignment for the device connection cables	75
15	Maintenance	76
15.1	General maintenance information	76
15.2	Repairs, servicing	76
15.3	Disassembling, packing, disposing	76
16	Specifications for Leuze end devices	77
16.1	Standard setting, KONTURflex (S4 switch position 0)	77
16.2	Bar code reader BCL 8 (S4 switch position 1)	79
16.3	Bar code reader BCL 22 (S4 switch position 2)	80
16.4	Bar code reader BCL 300i, BCL 500i, BCL 600i (S4 switch position 4)	81
16.5	Bar code reader BCL 90, BCL 900i (S4 switch position 5)	82
16.6	LSIS 122, LSIS 222 (S4 switch position 6)	83
16.7	LSIS 4x2i, DCR 202i (S4 switch position 7)	84
16.8	Hand-held scanner (S4 switch position 8)	85
16.9	RFI, RFM, RFU RFID readers (S4 switch position 9)	86
16.10	BPS 8 bar code positioning system (S4 switch position A)	87
16.11	BPS 300i bar code positioning system, ODSL xx optical distance sensors with RS 232 interface (S4 switch position B)	88
16.12	Modular interfacing unit MA 3x (S4 switch position C)	90
16.13	Resetting the parameters (S4 switch position F)	91
17	Appendix	92
17.1	ASCII Table	92

1 General information

1.1 Explanation of symbols

The symbols used in this operating manual are explained below.



Attention!

This symbol precedes text messages which must strictly be observed. Failure to comply with this information results in injuries to persons or damage to the equipment.



Notice!

This symbol indicates text passages containing important information.

1.2 Declaration of Conformity

The MA 238*i* modular interfacing units have been designed and manufactured in accordance with applicable European directives and standards.



Notice!

The Declaration of Conformity for these devices can be requested from the manufacturer.

The manufacturer of the product, Leuze electronic GmbH + Co. KG in D-73277 Owen, possesses a certified quality assurance system in accordance with ISO 9001.

The modular interfacing unit is "UL LISTED" in accordance with American and Canadian safety standards and fulfills the requirements of Underwriter Laboratories Inc. (UL).



EtherCAT® is a licensed and registered brand of Beckhoff Automation GmbH.

1.3 Description of functions

The MA 238*i* modular interfacing unit is used to connect Leuze devices directly to the fieldbus.

Bar code reader:	BCL 8, 22, 300i, 500i, 600i, 90, 900i
2D-code reader:	LSIS 122, LSIS 222, LSIS 4x2i, DCR 200i
Hand-held scanner	ITxxxx, HFU/HFM
RFID read-write devices:	RFM 12, 32, 62 & RFI 32, RFU 100, RFU 200
Bar code positioning system:	BPS 8, BPS 300
Optical distance sensors:	ODSL 9, ODSL 30, ODSL 96B
Measuring light curtain:	KONTURflex to Quattro-RSX/M12
multiNet master connection box:	MA 3x
Additional RS 232 devices:	Scales, third-party devices

This is accomplished by transmitting the data from the DEV via an RS 232 (V.24) interface to the MA 238*i* where a module converts it into the EtherCAT format. The data format on the RS 232 interface corresponds to the Leuze standard data format (9600bd, 8N1 and STX, data, CR, LF).

The corresponding Leuze devices are selected using a rotary code switch on the circuit board of the connector unit. Many additional RS 232 devices can be connected through a universal position.

Leuze electronic can only provide support for the devices offered in the product range.

1.4 Definition of terms

For better understanding of the explanations provided in this document, a definition of terms follows below:

- **Bit designation:**
The 1st bit or byte begins with count number "0" and means bit/byte 2^0 .
- **Data length:**
Size of a valid, continuous data packet in bytes.
- **ESI file (EtherCat Slave Information):**
Description of the device for the control.
- **Consistent:**
Data which belongs together with regard to content and which must not be separated is referred to as consistent data. When identifying objects, it must be ensured that the data is transmitted completely and in the correct order, otherwise the result is falsified.
- **Leuze device (DEV):**
Leuze devices, e.g., bar code readers, RFID readers, VisionReader...
- **Online command:**
These commands refer to the respective, connected ident device and may be different depending on the device. These commands are not interpreted by the MA 238*i*, but are instead transmitted transparently (see description of Ident device).
- **CR:**
Cross reference.
- **Perspective of I/O data in the description:**
Output data is data which is sent by the control to the MA. Input data is data which is sent by the MA to the control.
- **Toggle bits:**
 - Status toggle bit**
Each change of state indicates that an action was performed, e.g., bit ND (new data): each change of state indicates that new received data was transmitted to the PLC.
 - Control toggle bit**
An action is performed on each change of state, e.g., bit SDO: on each change of state, the registered data is sent by the PLC to the MA 238*i*.

2 Safety

This device was developed, manufactured and tested in line with the applicable safety standards. It corresponds to the state of the art.

2.1 Intended use

The MA 238*i* modular interfacing unit is used for connecting Leuze devices such as bar code or 2D-code readers, hand-held scanners, RFID read-write devices, etc. directly to the fieldbus.



CAUTION

Observe intended use!

↪ Only operate the device in accordance with its intended use. The protection of personnel and the device cannot be guaranteed if the device is operated in a manner not complying with its intended use.

Leuze electronic GmbH + Co. KG is not liable for damages caused by improper use.

↪ Read the technical description before commissioning the device. Knowledge of this technical description is an element of proper use.

NOTICE

Comply with conditions and regulations!

↪ Observe the locally applicable legal regulations and the rules of the employer's liability insurance association.



Attention

For UL applications, use is permitted exclusively in Class 2 circuits according to NEC (National Electric Code).

2.2 Foreseeable misuse

Any use other than that defined under "Intended use" or which goes beyond that use is considered improper use.

In particular, use of the device is not permitted in the following cases:

- Rooms with explosive atmospheres
- As stand-alone safety component in accordance with the machinery directive ¹⁾
- For medicinal purposes

1) Use as safety-related component within the safety function is possible, if the component combination is designed correspondingly by the machine manufacturer.

NOTICE

Do not modify or otherwise interfere with the device.

- ✎ Do not carry out modifications or otherwise interfere with the device.
The device must not be tampered with and must not be changed in any way.
The device must not be opened. There are no user-serviceable parts inside.
Repairs must only be performed by Leuze electronic GmbH + Co. KG.

2.3 Competent persons

Connection, mounting, commissioning and adjustment of the device must only be carried out by competent persons.

Prerequisites for competent persons:

- They have a suitable technical education.
- They are familiar with the rules and regulations for occupational safety and safety at work.
- They are familiar with the technical description of the device.
- They have been instructed by the responsible person on the mounting and operation of the device.

Certified electricians

Electrical work must be carried out by a certified electrician.

Due to their technical training, knowledge and experience as well as their familiarity with relevant standards and regulations, certified electricians are able to perform work on electrical systems and independently detect possible dangers.

In Germany, certified electricians must fulfill the requirements of accident-prevention regulations BGV A3 (e.g. electrician foreman). In other countries, there are respective regulations that must be observed.

2.4 Disclaimer

Leuze electronic GmbH + Co. KG is not liable in the following cases:

- The device is not being used properly.
- Reasonably foreseeable misuse is not taken into account.
- Mounting and electrical connection are not properly performed.
- Changes (e.g., constructional) are made to the device.

3 Fast commissioning / operating principle



Notice!

Below you will find a **short description for the initial commissioning** of the EtherCAT gateway MA 238*i*. Detailed explanations for the listed points can be found throughout the handbook.

3.1 Mounting

The gateway mounting plate MA 238*i* can be mounted in two different ways:

- using four threaded holes (M6) or
- using two M8x6 screws on the two lateral grooves.

3.2 Device arrangement and selection of the mounting location

Ideally, the MA 238*i* should be mounted so that it is easily accessible near the Ident device in order to ensure good operability, e.g., for configuring the connected device.

Detailed information can be found in chapter 6.3.1.

3.3 Electrical connection

The devices from the MA 2xx*i* family feature four M12 connectors/sockets which are coded differently depending on the interface.

The voltage supply (**PWR IN**) as well as the switching inputs/outputs (**PWR OUT** or **PWR IN**) are connected there. The number and function of the switching inputs/outputs is dependent on the connected end device.

An internal RS 232 interface is used for connecting the respective Leuze device. Another internal RS 232 interface functions as a service interface for configuring the connected device via a serial null modem cable.

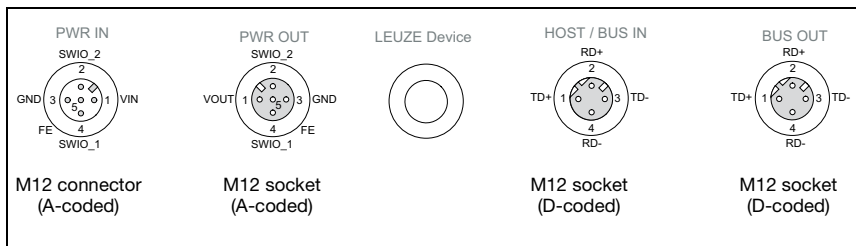

Figure 3.1: MA 238*i* connections

Detailed information can be found in chapter 7.

3.3.1 Connecting the Leuze device

- ↳ To connect the Leuze device to the internal RS 232 device interface, open the housing of the MA 238*i* and lead the corresponding device cable (see chapter 14.6) through the middle threaded opening.
- ↳ Connect the cable to the internal device interface (**X30**, **X31** or **X32**, see chapter 7.5.1).
- ↳ Use rotary switch **S4** (see chapter 8.2.5) to select the connected device.
- ↳ Now screw the PG cable gland into the threaded opening to provide strain relief and ensure protection class IP 65.
- ↳ Finally, close the housing of the MA 238*i*.



Attention!

Only then may the supply voltage be applied.

Upon startup of the MA 238*i*, the device selection switch is queried and the gateway automatically sets itself to the Leuze device.

Connecting functional earth FE

- ↳ Ensure that the functional earth (FE) is connected correctly.

Unimpaired operation is only guaranteed when the functional earth is connected properly. All electrical disturbances (EMC couplings) are discharged via the functional earth connection.

3.3.2 Connecting the power supply and the bus cable

- ↳ Ideally, use the ready-made cables listed in chapter 14.4.3 to connect the gateway to the power supply via the **PWR IN** connection.
- ↳ The ready-made cables listed in chapter 14.5.4 are preferred for connecting the gateway to the fieldbus via the **HOST / BUS IN** connection.
- ↳ If applicable, use the **BUS OUT** connection if you would like to construct a network with linear topology.

3.4 Starting the device

- ↳ Apply the supply voltage +18 ... 30VDC (typ. +24VDC); the MA 238*i* starts up. The PWR LED displays that it is ready for operation.

3.5 MA 238*i* on the EtherCat

3.5.1 Device description file

For EtherCAT, all process data and parameters are described in objects. The compilation of all process data and parameters of the gateway - the object directory - is stored in a so-called ESI file (EtherCAT Slave Information).

The ESI file contains all objects with index, sub-index, name, data type, default value, minimum and maximum, and access possibilities. That means the ESI file describes the entire functionality of the MA 238*i*.

The ESI file has the name MA 238*i*.xml and is available for download on the Leuze home page.

Vendor ID for the MA 238*i*

The Vendor ID assigned by Leuze electronic for the MA 238*i* is 121_h = 289_d.

Detailed information on the device description file and the object directory can be found in chapter 12.5.3.

3.5.2 Device profile

The device profile describes the application parameters and the functional behavior of the MA 238*i*. For EtherCAT, one does not specify individual device profiles for device classes. Instead, simple interfaces for existing device profiles are provided.

3.5.3 Starting up the MA 238*i* in the EtherCAT system

As is common for EtherCAT, the gateway runs through different states when starting up: "INIT", "PREOP", "SAFEOP" and "OPERATIONAL".

Detailed information can be found in chapter 12.4.

4 Device description

4.1 General Information to the connector units

The modular interfacing unit of the MA 2xx*i* family is a versatile gateway for integrating Leuze RS 232 devices (e.g., BCL 22 bar code readers, RFID devices, RFM 32, ...) into the respective fieldbus. The MA 2xx*i* gateways are intended for use in industrial environments with a high protection class. Various device versions are available for the conventional fieldbuses. With a stored parameter structure for the connectable RS 232 devices, commissioning could hardly be simpler.

4.2 Characteristics of the connector units

A special characteristic of the MA 238*i* device family are three function modes:

1. **Transparent mode**

In this function mode, the MA 238*i* functions as a pure gateway with automatic communication from and to the PLC. Absolutely no special programming by the user is necessary for this purpose. The data is not buffered or stored temporarily, however. Instead, it is "passed on".

The programmer must make certain to retrieve the data from the input memory of the PLC at the right time, as it is otherwise overwritten by new data.

2. **Collective mode**

In this operating mode, data and telegram parts are temporarily stored in the memory (buffer) of the MA and sent to the RS 232 interface or to the PLC in a telegram by means of bit activation. In this mode, however, all communication control must be programmed on the PLC.

This function mode is helpful, for example, for very long telegrams or when one or more codes with long code lengths are read.

3. **Command mode**

With this special operating mode, it is possible to use the first bytes of the data range to transmit predefined commands to the connected device by means of bit activation. For this purpose, device-dependent commands (so-called online commands) are predefined via the device selection switch, see chapter 16 "Specifications for Leuze end devices".

4.3 Device construction

The MA 238*i* modular interfacing unit is used for interconnecting Leuze devices, such as the BCL 8, BCL 22, etc., directly to the fieldbus. This is accomplished by transmitting the data from the Leuze device via an RS 232 (V.24) interface to the MA 238*i* where a module converts it into the fieldbus format. The data format of the RS 232 interface corresponds to the standard Leuze data format.

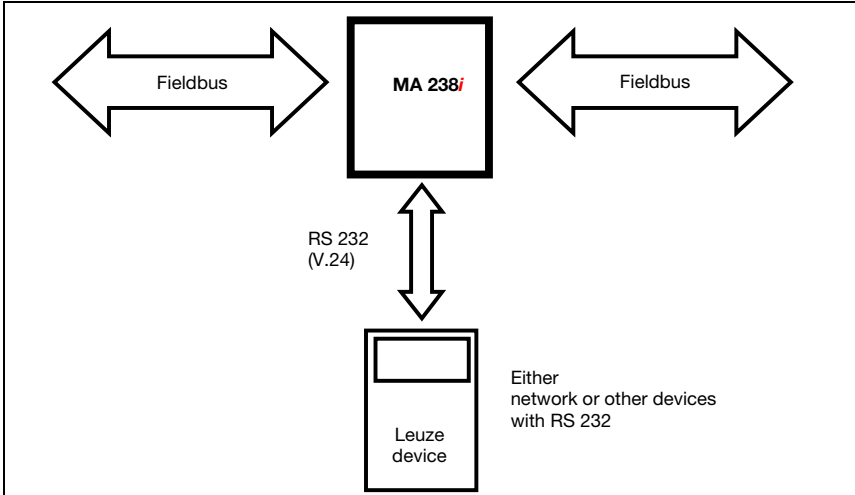

Figure 4.1: Connection of a Leuze device (BCL, RFI, RFM, ...) to the fieldbus

The cable of the respective Leuze device is guided through cable bushings with PG cable glands into the MA 238*i* and connected there with the PCB connectors.

The MA 238*i* is intended as a gateway for any RS 232 devices, e.g., BCL 300i, hand-held scanners, scales or for coupling a multiNet network.

The RS 232 cables are internally connectable using JST plug connectors. The cable can be connected to the device using a stable PG cable gland which provide strain relief and protection against contamination.

With the help of adapter cables with Sub-D 9 or open cable end, other RS 232 devices can also be connected.

4.4 Operating modes

For fast commissioning, the MA 238*i* offers an additional operating mode, the "Service mode", in addition to the "Standard mode". In this operating mode, the Leuze device can, for example, be configured on the MA 238*i* and the network settings of the MA can be displayed. To do this, you need a PC/laptop with a suitable terminal program, as BCL-Config from Leuze or similar.

Service switch

Select between "operation" and "service" modes with the service switch. You have the following options:

Pos. RUN:

Operation

The Leuze device is connected to the fieldbus and communicates with the PLC.

Pos. DEV:

Service Leuze device

The connection between the Leuze device and the fieldbus is interrupted. With this switch position, you can communicate directly with the Leuze device at the fieldbus gateway via RS 232. You can send online commands via the service interface, configure the Leuze device using the corresponding BCL- BPS-, ...-Config configuration software and have the read data of the Leuze device output.

Pos. MA:

Service fieldbus gateway

With this switch setting, your PC/terminal is connected with the fieldbus gateway. In doing so, the current setting values of the MA (e.g. address, RS 232 parameters) can be called up via a command.

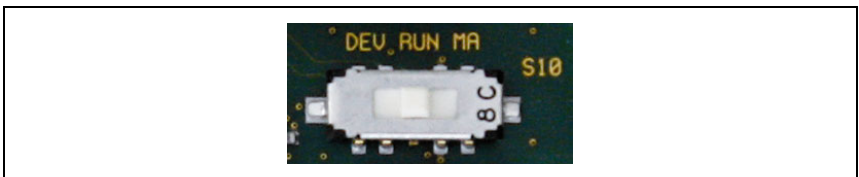

Figure 4.2: Service-switch switch positions



Notice!

If the service switch is on one of the service settings, the PWR LED flashes on the front side of the device, see chapter 8.1.2 "LED indicators on the housing".

Furthermore, on the control, the SMA service bit of the status bytes signals that the MA is in service mode.

Service interface

The service interface can be accessed once the MA 238*i* housing cover has been removed and features a 9-pin Sub-D connector (male). A crossed RS 232 connection cable is required to make the Rx/D, Tx/D and GND connections.

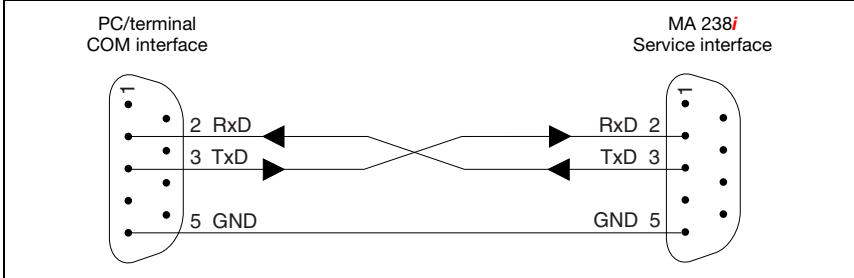

Figure 4.3: Connecting the service interface to a PC/terminal



Attention!

For the service PC to function, the RS 232 parameters must be the same as those of the MA. The Leuze standard setting of the interface is 9600bd, 8N1 and STX, data, CR, LF.

4.5 Fieldbus systems

Various product variants of the MA 2xx*i* series are available for connecting to different fieldbus systems such as PROFIBUS DP, PROFINET-IO, DeviceNet and Ethernet or EtherCAT.

4.5.1 EtherCAT

General information about EtherCAT

EtherCAT is an Ethernet-based fieldbus initiated by the Beckhoff corporation. The EtherCAT Technology Group (ETG) is the official standardization partner of the IEC working groups.

EtherCAT has been an IEC standard since 2005.

- IEC 61158: protocols and services
- IEC 61784-2: Communication profiles for the specific device classes

All EtherCAT-specific communication mechanisms are described in detail in the standards mentioned above. This technical description will describe parts of the IEC standard if this assists general understanding.

EtherCAT topology

EtherCAT permits a multitude of topologies such as line, tree, ring, star and combinations of these. The bus or line structure known from the fieldbuses is thus also available for EtherCAT.

Telegrams are sent on a wire pair in the "processing direction" from the master to the slave. The EtherCAT device processes the frames only in this direction and passes them on to the

subsequent device until the telegram has passed through all devices. The last device sends the telegram back to the master on the second wire pair in the cable in the "forward direction". Here, the EtherCAT always forms a logical ring structure regardless of the topology installed.

From an Ethernet point of view, an EtherCAT bus segment is nothing more than a single, large Ethernet participant which sends and receives Ethernet telegrams. Within the "participant", however, there is a multitude of EtherCAT slaves rather than one single Ethernet controller with a downstream micro-processor.

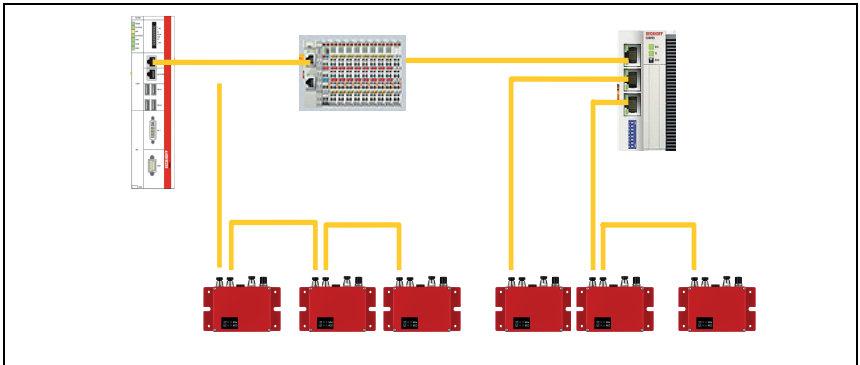

Figure 4.4: Topology example

5 Specifications

5.1 General specifications

Electrical data

Interface type	2x EtherCat, integrated switch, BUS: 2x M12 socket (D-coded) PWR/IO: 1x M12 connector (A-coded), 1x M12 socket (A-coded)		
protocols	EtherCat communication		
Baud rate	10/100MBAud		
	vendor ID	289Dec / 121H	
	device type	12Dec / 0CH (communications adapter)	
	position sensor type	Product type 04 (gateway)	
Data formats	Data bit: 8, parity: None, stop bit: 1		
Service interface	RS 232, 9-pin Sub-D connector, Leuze standard		
Switching input/output	1 switching input/1 switching output device-dependent voltage		
Operating voltage	18 ... 30VDC (PELV, Class 2) ¹⁾		
Power consumption	max. 5VA (without DEV, current consumption max. 300mA)		
Max stress on the connector (PWR IN/OUT)	3A		
Hand-held scanner operating voltage	4.75 ... 5.25VDC / max. 1A		

Indicators

LED L0 / A0	green	Connection possible
	yellow	Data transmission
LED L1 / A1	green	Connection possible
	yellow	Data transmission
PWR LED	green	Power
	red	Collection error
STA LED	green	Bus state ok
	red	Configuration error

Mechanical data

Protection class	IP 65 (with screwed-on M12 and connected Leuze device)
Weight	700 g
Dimensions (HxWxD)	130 x 90 x 41 mm / with plate: 180 x 108 x 41 mm
Housing	Diecast aluminum
Connection	2 x M12: BUS IN / BUS OUT PROFINET-IO 1 connector: RS 232 1 x M12: Power IN/GND and switching input/output 1 x M12: Power OUT/GND and switching input/output

Environmental data

Operating temperature range	0°C ... +55°C
-----------------------------	---------------

Storage temperature range	-20°C ... +60°C
Air humidity	Max. 90% rel. humidity, non-condensing
Vibration	IEC 60068-2-6, test FC
Shock	IEC 60068-2-27, test Ea
Electromagnetic compatibility	EN 61000-6-3:2007 (interference emissions for residential, commercial and light-industrial environments) EN 61000-6-2:2005 (interference rejection for industrial sectors)
Certifications	UL 60950-1, CSA C22.2 No. 60950-1 ¹⁾

1) For UL applications: only for use in "Class 2" circuits acc. to NEC.

5.2 Dimensioned drawings

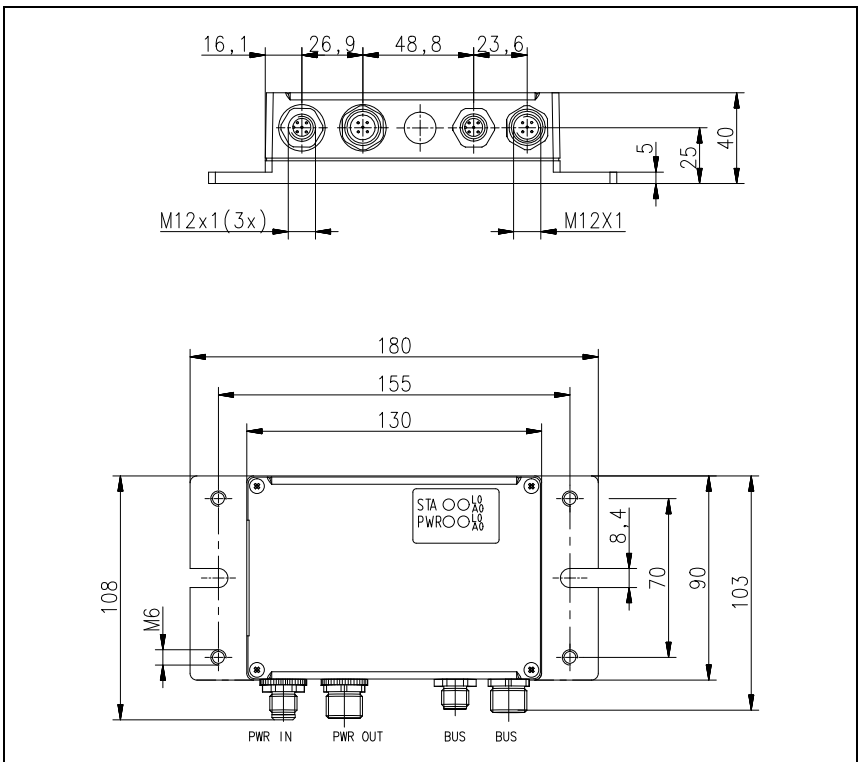

Figure 5.1: MA 238*i* dimensioned drawing

5.3 Type overview

The following versions of the MA 2xx*i* gateway family are available for facilitating the integration of Leuze RS 232 devices in the various fieldbus types.

Fieldbus	Device type	Part no.
PROFIBUS DP V0	MA 204 <i>i</i>	50112893
Ethernet TCP/IP	MA 208 <i>i</i>	50112892
PROFINET-IO RT	MA 248 <i>i</i>	50112891
DeviceNet	MA 255 <i>i</i>	50114156
CANopen	MA 235 <i>i</i>	50114154
EtherCAT	MA 238 <i>i</i>	50114155
EtherNet/IP	MA 258 <i>i</i>	50114157

Table 5.1: Type overview MA 2xx*i*

6 Installation and mounting

6.1 Storage, transportation



Attention!

When transporting or storing, package the device so that it is protected against collision and humidity. Optimal protection is achieved when using the original packaging. Heed the required environmental conditions specified in the technical data.

Unpacking

- ↳ Check the packaging for any damage. If damage is found, notify the post office or shipping agent as well as the supplier.
- ↳ Check the delivery contents using your order and the delivery papers:
 - Delivered quantity
 - Device type and model as indicated on the name plate
 - Brief manual

The name plate provides information as to what MA 2xx*i* type your device is. For specific information, please refer to the package insert or chapter 14.2.

Name plate of the connector unit



Figure 6.1: MA 238*i* device name plate



Note!

Please note that the shown name plate is for illustration purposes only; the contents do not correspond to the original.

- ↳ Save the original packaging for later storage or shipping.

If you have any questions concerning your shipment, please contact your supplier or your local Leuze electronic sales office.

↳ *Observe the applicable local regulations when disposing of the packaging materials.*

6.2 Mounting

The gateway mounting plate MA 238*i* can be mounted in two different ways:

- using four threaded holes (M6) or
- using two M8 screws on the two lateral grooves.

Fastening by means of four M6 or two M8 screws

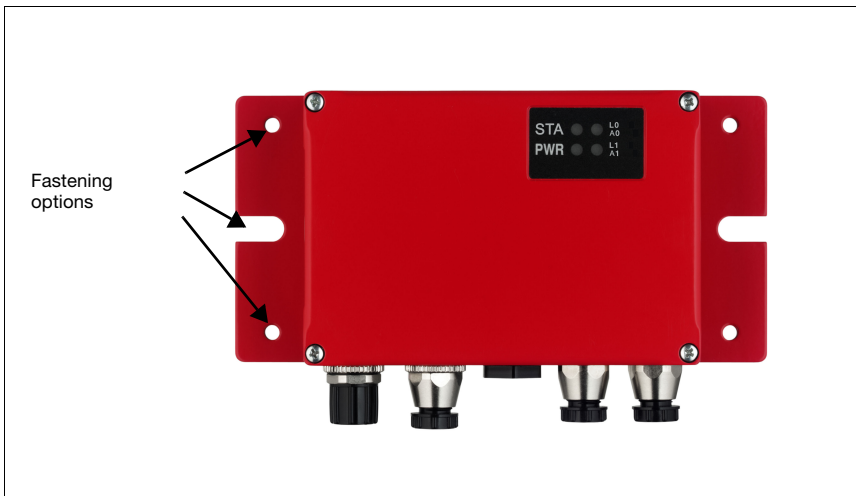

Figure 6.2: Fastening options

6.3 Device arrangement

Ideally, the MA 238*i* should be mounted so that it is easily accessible near the Ident device in order to ensure good operability - e.g., for configuring the connected device.

6.3.1 Selecting a mounting location

In order to select the right mounting location, several factors must be considered:

- The permissible cable lengths between the MA 238*i* and the host system depending on which interface is used.
- The housing cover should be easily accessible, so that the internal interfaces (device interface for connecting the Leuze device via PCB connectors, service interface) and other operational controls are easy to reach.
- Maintaining the required environmental conditions (temperature, humidity).
- Lowest possible chance of damage to the MA 238*i* by mechanical collision or jammed parts.

6.4 Cleaning

↳ *Clean the housing of the MA 238*i* with a soft cloth after mounting. Remove all packaging remains, e.g. carton fibers or Styrofoam balls.*



Attention!

Do not use aggressive cleaning agents such as thinner or acetone for cleaning the device.

7 Electrical connection

The fieldbus gateways MA 2xx*i* are connected using variously coded M12 connectors.

An RS 232 device interface allows the respective devices to be connected with system connectors. The device cables are equipped with a prefabricated PG cable gland.

Coding varies and the design is implemented as either socket or connector depending on the HOST (fieldbus) interface and function. For the exact design, refer to the corresponding description of the MA 2xx*i* device type.



Notice!

The corresponding mating connectors and ready-made cables are available as accessories for all cables. For further information, see chapter 14 "Type overview and accessories".



Figure 7.1: Location of the electrical connections

7.1 Safety notices for the electrical connection



Attention!

Before connecting the device please ensure that the supply voltage matches the value printed on the nameplate.

Connection of the device and cleaning must only be carried out by a qualified electrician.

Ensure that the functional earth (FE) is connected correctly. Unimpaired operation is only guaranteed when the functional earth is connected properly.

If faults cannot be corrected, the device should be removed from operation and protected against possible commissioning.



Attention!

For UL applications, use is only permitted in class 2 circuits in accordance with the NEC (National Electric Code).



The fieldbus gateways are designed in accordance with safety class III for supply by PELV (protective extra-low voltage with reliable disconnection).



Notice!

Protection class IP65 is achieved only if the connectors and caps are screwed into place!

7.2 Electrical connection

The MA 238*i* features two M12 connectors/sockets for voltage supply; each is A-coded. The voltage supply (**PWR IN**) as well as the switching inputs/outputs (**PWR OUT** or **PWR IN**) are connected there. The number and function of the switching inputs/outputs is dependent on the connected end device. Two additional M12 sockets are used for connection to the fieldbus. Both of these connections are D-coded.

An internal RS 232 interface is used for connecting the respective Leuze device. Another internal RS 232 interface functions as a service interface for configuring the connected device via a serial null modem cable.

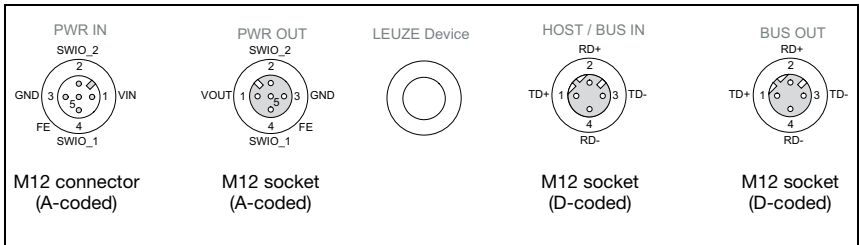

Figure 7.2: MA 238*i* connections

Described in detail in the following are the individual connections and pin assignments.



Attention!

Voltage supply and bus cable are coded in the same way. Please observe the printed connection designations

7.2.1 PWR IN – voltage supply / switching input/output

PWR IN (5-pin connector, A-coded)			
	Pin	Name	Remark
<p>PWR IN SWIO_2 2 GND 3 VIN 1 FE 4 SWIO_1 5 M12 connector (A-coded)</p>	1	VIN	Positive supply voltage +18 ... +30VDC
	2	SWIO_2	Switching input/switching output 2
	3	GND	Negative supply voltage 0VDC
	4	SWIO_1	Switching input/switching output 1
	5	FE	Functional earth
	Thread	FE	Functional earth (housing)

Table 7.1: PWR IN pin assignment



Notice!

The designation and function of the SWIO depends on the connected device. Please observe the following table!

Device	PIN 2	PIN 4
BCL 22	SWOUT_1	SWIN_1
BCL 8	SW_0	SW_I
Hand-held scanner/BCL 90	n.c.	n.c.
RFM/RFU/RFI	SWOUT_1	SWIN_1
LSIS 122, LSIS 222, DCR 202i	SWOUT	SWIN
LSIS 4x2/BCL 300, BCL 500, BCL 600i	configurable IO 1 / SWIO 3 IO 2 / SWIO 4	configurable
KONTURflex	n.c.	n.c.
ODSL 9, ODSL 96B	Q1	n.c.
ODSL 30	Q1	active/reference (on SWIN_1, PWRIN)

Table 7.1: Device-specific function of the SWIOs

Supply voltage



Attention!

For UL applications, use is only permitted in class 2 circuits in accordance with the NEC (National Electric Code).



The fieldbus gateways are designed in accordance with safety class III for supply by PELV (protective extra-low voltage with reliable disconnection).

Connecting functional earth FE



Notice!

Ensure that the functional earth (FE) is connected correctly. Unimpaired operation is only guaranteed when the functional earth is connected properly. All electrical disturbances (EMC couplings) are discharged via the functional earth connection.

Switching input/output

The MA 238*i* is equipped with the **SWIO_1** and **SWIO_2** switching inputs/outputs. This is located on the PWR IN M12 connector and on the PWR OUT M12 connector. The connection of the switching inputs/outputs from PWR IN to PWR OUT can be interrupted by means of a jumper. In this case, only the switching input and output on PWR IN are active.

The function of the switching inputs and outputs is dependent on the connected Leuze device. Detailed information on this topic can be found in the respective operating instructions.

7.2.2 PWR OUT switching input/output

PWR OUT (5-pin socket, A-coded)			
	Pin	Name	Remark
	1	VOUT	Voltage supply for additional devices (VOUT identical to VIN at PWR IN)
	2	SWIO_2	Switching input/switching output 2
	3	GND	GND
	4	SWIO_1	Switching input/switching output 1
	5	FE	Functional earth
	Thread	FE	Functional earth (housing)

Table 7.2: PWR OUT pin assignment



Notice!

The maximum admissible current of the PWR OUT and IN connectors is maximum 3A. To be subtracted from this is the current consumption of both the MA and of the connected end device.

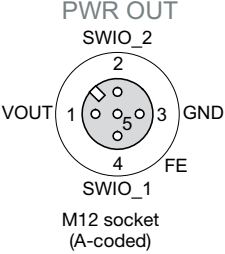
The function of the switching inputs and outputs is dependent on the connected Leuze device. Detailed information on this topic can be found in the respective operating instructions.

On delivery, the SWIO 1/2 are connected in parallel on PWR IN/OUT. This connection can be separated with a jumper.

7.3 BUS IN

The MA 238*i* makes an EtherCAT interface available as host interface.

BUS IN (4-pin socket, D-coded)			
	Pin	Name	Remark
	1	TD+	Transmit Data +
	2	RD+	Receive Data +
	3	TD-	Transmit Data -
	4	RD-	Receive Data -
	Thread	FE	Functional earth (housing)

Table 7.3: Pin assignment HOST / BUS IN

⚡ For the host connection of the MA 238*i*, the "KB ET - ... - SA-RJ45" ready-made cables are preferred, see table 14.4 Bus connection cable for the MA 238ion page 74.

EtherCAT cable assignments

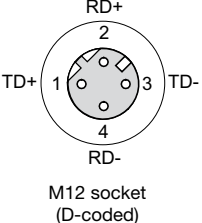
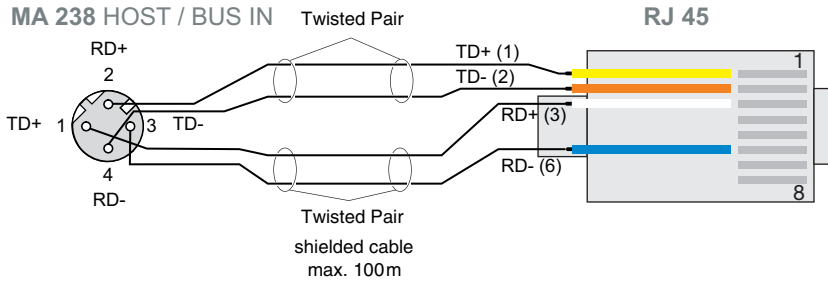

RJ45 - assignment and wire colors

Pin	Signal	Name	Wire color according to PROFINET	Wire color according to EIA T568B
1	TD+	Transmission Data +	yellow	white/orange
2	TD-	Transmission Data -	orange	orange
3	RD+	Receive Data +	white	white/green
6	RD-	Receive Data -	blue	green

Figure 7.3: HOST/BUS IN cable assignments on RJ-45 (shown here is the device connection)



Notice for connecting the EtherCAT interface!

Ensure adequate shielding. The entire connection cable must be shielded and earthed. The RD+/RD- and TD+/TD- wires must be stranded in pairs. Use CAT 5 cable for the connection.

7.4 BUS OUT

BUS OUT (4-pin socket, D-coded)			
	Pin	Name	Remark
	1	TD+	Transmit Data +
	2	RD+	Receive Data +
	3	TD-	Transmit Data -
	4	RD-	Receive Data -
Thread	FE	Functional earth (housing)	

Table 7.4: Pin assignment HOST/BUS OUT

↪ For the host connection of the MA 238*i*, the "KB ET - ... - SSA" ready-made cables are preferred, see table 14.4 Bus connection cable for the MA 238*ion* page 74.

If you use user-configurable cables, note the following:

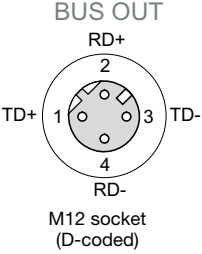

Notice!

Ensure adequate shielding. The entire connection cable must be shielded and earthed. The signal lines must be stranded in pairs. Use CAT 5 cable for the connection.



Notice!

For the MA 238*i* as standalone device or as the last participant in a linear topology, termination on the BUS OUT socket is **not** mandatory!

7.5 Device interfaces

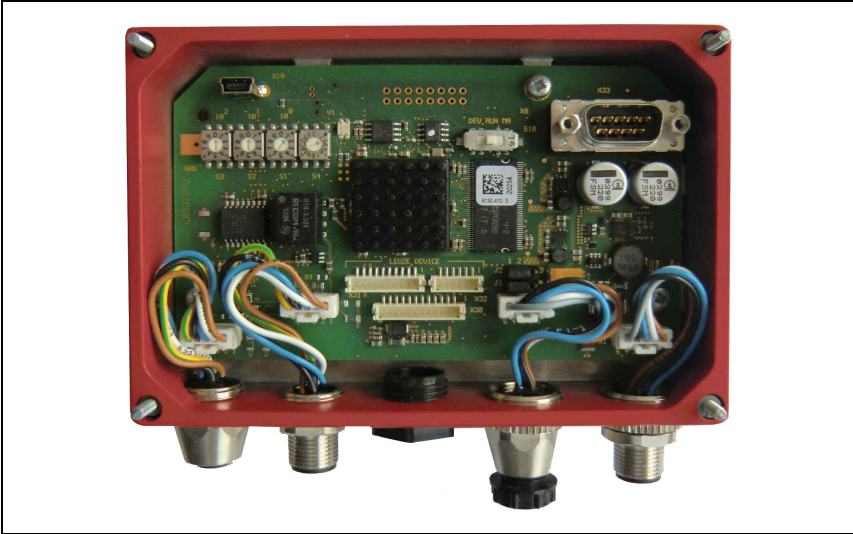

Figure 7.4: Open the MA 238*i*

7.5.1 RS 232 device interface (accessible after opening the device, internal)

The device interface is prepared for the system plugs (PCB connectors) for Leuze devices RFI xx, RFM xx, BCL 22.

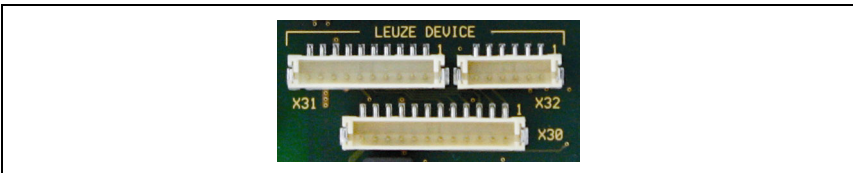

Figure 7.5: RS 232 device interface

The standard devices are connected with 6- or 10-pin connector piece to X31 or X32, respectively. For hand-held scanners, BCL 8 and BPS 8 with 5VDC $\pm 10\%$ supply (from the MA) on pin 9, the 12-pin X30 PCB connection is available as well.

By using an additional cable (cf. "Type overview and accessories" on page 71), the system connection can be established on M12 or 9-pin Sub-D, e.g., for hand-held scanners.



Notice!

When using third-party devices, check the pin assignment and voltage without fail.

7.5.2 Service interface (internal)

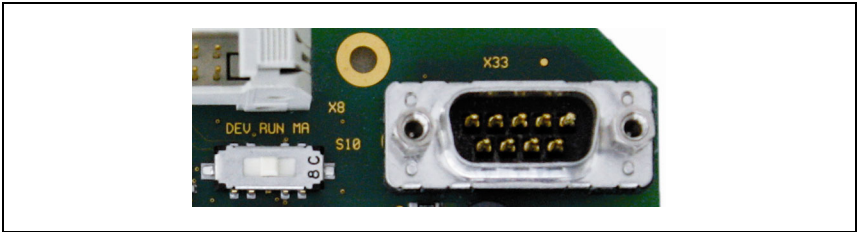

Figure 7.6: RS 232 service switch and service interface

Following activation, this interface enables access via the RS 232 to the connected Leuze device and the MA for configuration using the 9-pin Sub-D. The connection between the fieldbus interface and the device interface is switched off during access. The fieldbus itself is, however, not interrupted as a result.

The service interface can be accessed once the MA 238*i* housing cover has been removed and features a 9-pin Sub-D connector (male). A crossed RS 232 connection cable is required to make the RxD, TxD and GND connections. A hardware handshake via RTS, CTS is not supported at the service interface.

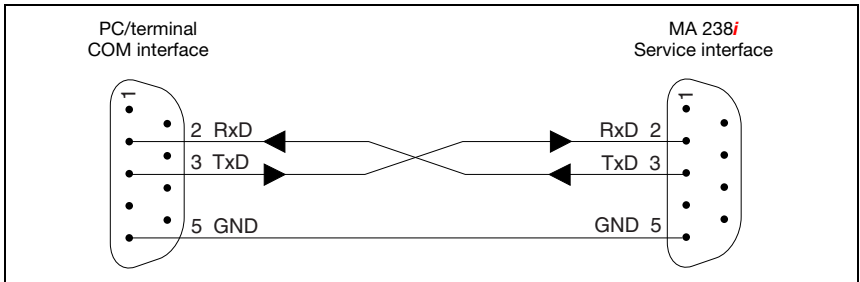

Figure 7.7: Connecting the service interface to a PC/terminal



Attention!

For the service PC to function, the RS 232 parameters must be the same as those of the MA. The Leuze standard setting of the interface is 9600Bd, 8N1 and STX, data, CR, LF.



Notice!

To configure the devices connected to the external interface, e.g., BCL 8 (JST plug connector "X30"), a cable specially configured for this purpose is necessary. The service switch must be in the "DEV" or "MA" position (Service Leuze device/MA).

7.6 EtherCAT wiring

A Cat. 5 Ethernet cable should be used for wiring.

For the connection technology transition from M12 to RJ45, a "KDS ET M12 / RJ 12 45 W - 4P" adapter is available that lets you connect standard network cables.

If no standard network cables are to be used (e.g., due to lacking IP... protection class), you can use the "KB ET - ... - SA" user-configurable cables on the side of the MA 238*i*, see table 14.4 Bus connection cable for the MA 238ion page 74.

The individual MA 238*i* devices in a linear topology are connected with the "KB ET - ... - SSA" cable, see "Bus connection cable for the MA 238*i*" on page 74.

For unavailable cable lengths, you can configure your cables yourself. When doing so, make certain that you connect **TD+** on the M12 connector with **RD+** on the RJ-45 connector and **TD-** on the M12 connector with **RD-** on the RJ-45 connector, respectively, etc.



Notice!

Use the recommended connectors / sockets or the ready-made cables (see chapter 14 "Type overview and accessories").

For further information on the topologies, see chapter 4.5.1 "EtherCAT".

7.7 Cable lengths and shielding

 Observe the following maximum cable lengths and shielding types:

Connection	Interface	Max. cable length	Shielding
MA 238<i>i</i> – Service	RS 232	10m	not necessary
MA 238<i>i</i> – Host	EtherCAT	100m	absolutely required, shielded
Network from the first MA 238<i>i</i> to the last MA 238<i>i</i>	EtherCAT	the maximum segment length must not exceed 100m for 100Base-TX Twisted Pair (min. Cat. 5)	absolutely required, shielded
MA 238<i>i</i> – Power supply unit		30m	not necessary
Switching input		10m	not necessary
Switching output		10m	not necessary

Table 7.5: Cable lengths and shielding

8 Status displays and operational controls

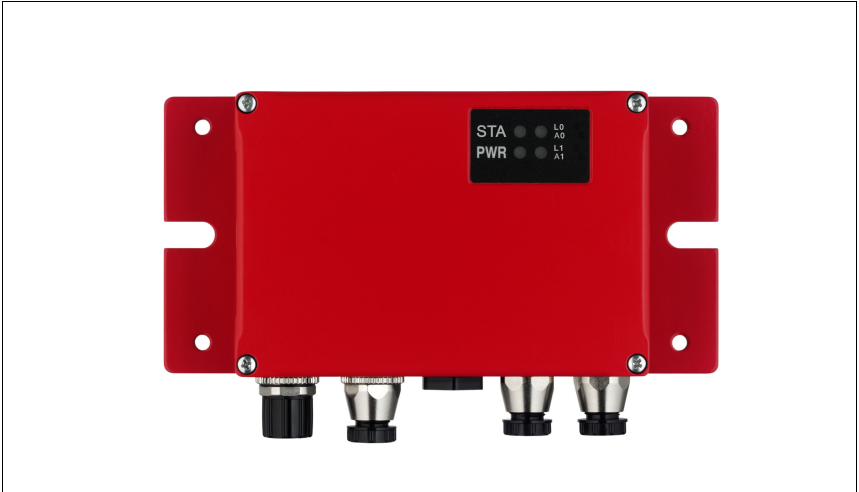





Figure 8.1: LED indicators on the MA 238*i*

8.1 LED status indicators





8.1.1 LED indicators on the circuit board

LED (Status)



	off	Device OFF - no operating voltage or device defect
	continuous green light	Device ok - readiness for operation
	continuous orange light	Device error / firmware available
	flashing green-orange	Device in boot mode - no firmware

8.1.2 LED indicators on the housing



PWR LED

PWR 	off	Device OFF - no operating voltage or device error
PWR 	continuous green light	Device ok - self test successfully finished - ready
PWR 	flashing green	Device ok, device in service mode
PWR 	flashing red	Configuration error - baud rate or address incorrect



STA LED

STATUS 	continuous green light	Bus operation ok - network mode ok - connection and communication to the host established
STATUS 	continuous red light	Configuration error - network error - no connection established - no communication possible

L0/A0 LED

 L0 A0	continuous green light	L0 - connection exists
 L0 A0	flashing yellow	A0 - data exchange

L1/A1 LED

 L1 A1	continuous green light	L1 - connection exists
 L1 A1	flashing yellow	A1 - data exchange

8.2 Internal interfaces and operational controls

8.2.1 Overview of operational controls of the

The operational controls of the MA 238*i* are described in the following. The figure shows the MA 238*i* with opened housing cover.

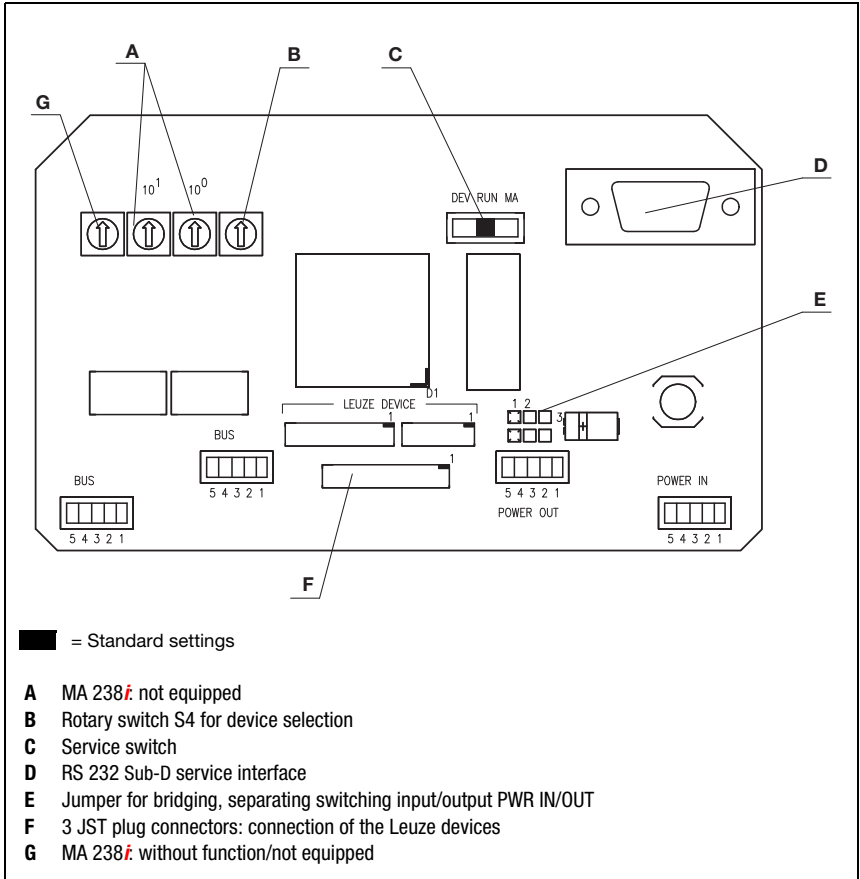

Figure 8.2: Front view: operational controls of the MA 238*i*

Circuit board element desig.	Function
X1 Operating voltage	PWR IN M12 connector for operating voltage (18 ... 30VDC) MA 238 <i>i</i> and connected Leuze device xx
X2 Output voltage	PWR OUT M12 connector for other devices (MA, BCL, sensor, ...) VOUT = VIN max. 3A
X4 HOST interface	BUS IN HOST interface for connecting to the fieldbus
X5 HOST interface	BUS OUT Second BUS interface for creating a network with other participants in a linear topology
X30 Leuze device	JST plug connector with 12 pins Connection of the Leuze devices with 4.75 ... 5.25VDC / 1A (BCL 8, BPS 8 and hand-held scanner)
X31 Leuze device	JST plug connector with 10 pins Connection of the Leuze devices (BCL, RFI, RFM,...) Pin VINBCL with standard setting = V+ (18 - 30V)
X32 Leuze device	JST plug connector with 6 pins Connection of the Leuze devices (BCL, RFI, RFM,...) Pin VINBCL with standard setting = V+ (18 - 30V)
X33 RS 232 service interface	9-pin SUB-D connector RS 232 interface for service/setup operation. Enables the connection of a PC via serial null modem cable for configuring the Leuze device and the MA 238 <i>i</i>
S4 Rotary switch	Rotary switch (0 ... F) for device selection Standard setting = 0
S10 DIP switch	Service switch Switch between service Leuze device (DEV), service fieldbus gateway (MA) and operation (RUN). Standard setting = operation.
J1, J2 Jumper	Bridging, separating switching input/output (interruption of connection between the two PWR M12 connectors of the SWIO 1 or SWIO 2)

8.2.2 Connector X30 ... connectors

PCB connectors **X30 ... X32** are available in the MA 238*i* for connecting the respective Leuze devices via RS 232.

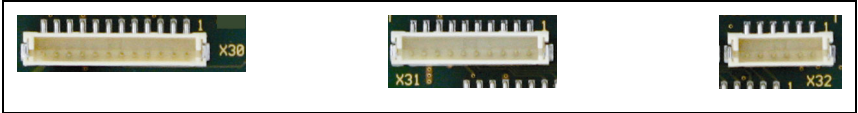

Figure 8.3: Connections for Leuze devices



Attention!

Several Leuze devices may not be connected to the MA 238*i* simultaneously, as only one RS 232 interface can be operated.

8.2.3 RS 232 service interface – X33

The **X33** RS 232 interface facilitates the configuration of the Leuze device and the MA 238*i* via PC, which is connected by means of a serial null modem cable.

X33 pin assignment – service connector

SERVICE (9-pin SUB-D connector)			
	Pin	Name	Remark
	2	RXD	Receive Data
	3	TXD	Transmit Data
	5	GND	Functional earth

Table 8.1: SERVICE pin assignment

8.2.4 S10 service switch

The **S10** DIP switch can be used to select between the "operation" and "service" modes, i.e. you switch between the following options here:

- Operation (RUN) = default setting
- Service Leuze device (DEV) and
- Service fieldbus gateway (MA)

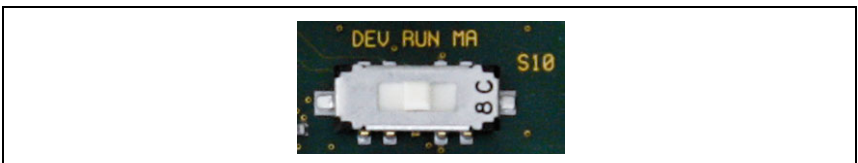

Figure 8.4: DIP switch service - operation

For further information on the corresponding options, see chapter 4.4 "Operating modes".

8.2.5 Rotary switch S4 for device selection

The **S4** rotary switch is used to select the Leuze end device.

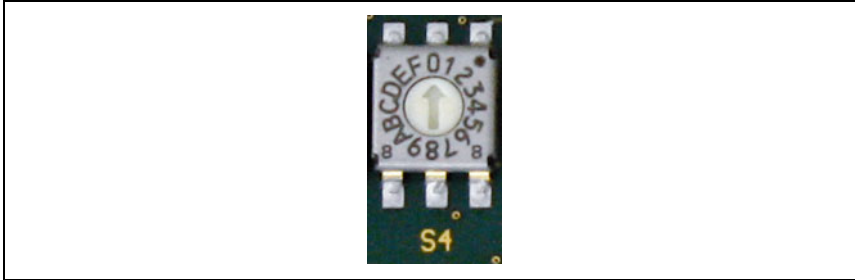

Figure 8.5: Rotary switch for device selection

The following switch positions are assigned to the Leuze devices:

Leuze device	Switch position	Leuze device	Switch position
Standard setting			
Other RS 232 devices such as KONTURflex QUATTRO	0	LSIS 4x2i, DCR 202i	7
BCL 8	1	Hand scanner	8
BCL 22	2	RFID (RFI xx, RFM xx, RFU xx)	9
n.c.	3	BPS 8	A
BCL 300i, BCL 500i, BCL 600i	4	ODS 9, ODSL 30, ODSL 96B, BPS 300i	B
BCL 90, BCL 900i	5	MA 3x	C
LSIS 122, LSIS 222	6	Reset to factory setting	F

The gateway is set via the switch position on the Leuze device. If the switch position is changed, the device must be restarted, since the switch position is only queried after switching off completely and then restarting the device.



Notice!

In switch position "0", a distance of >20ms must be maintained between two telegrams so they can be distinguished from one another.

The parameters of the Leuze end devices are described in chapter 16.

9 Configuration

The MA 238*i* is configured using the ESI file via the device manager of the control. The connected device is normally configured via the service interface of the MA with the help of a suitable configuration program.

The respective configuration programs – e.g. for bar code readers the BCL-Config, for RFID devices the RF-Config etc. – and the associated documentation is provided on the Leuze home page www.leuze.com in the respective Download area.



Notice!

In order to display the help texts, a PDF viewer program (not included in the delivery contents) must also be installed. For important information on configuring and on the configurable functions, please refer to the description of the respective device.

Index	Name	Flags	Value
1000	Device Type	RO	
1018:0	Identity Object	M RO	> 4 <
1600:0	RxPDO	RW	> 1 <
1A00:0	TxPDO	RW	> 3 <
1C12:0	Sync Manager 2 PDO Assignment	RW	> 1 <
1C13:0	Sync Manager 3 PDO Assignment	RW	> 1 <
6000:0	Inputs	RW	> 3 <
7000:0	Outputs	RW	> 1 <
8000:0	Serial Settings	RW	> 6 <

List of supported objects

Configurable Tx and Rx process data objects

Box 1 (MA238i V0.9.4)

- TxPDO
 - 8 Byte In (1)
 - 8 Byte In (2)
 - 8 Byte In (3)
- RxPDO
 - 8 Byte Out (1)
- WcState
- InfoData

Figure 9.1: Configuration options

9.1 Connecting the service interface

The RS 232 service interface is connected after opening the device cover of the MA 238*i* via the 9-pin Sub-D and a cross-wired null modem cable (Rx/D/TXD/GND). For connection, see chapter "Service interface (internal)" on page 31.

The service interface is activated with the help of the service switch and establishes a direct connection to the connected device with the "DEV" (Leuze device) or "MA" (gateway) setting.

9.2 Reading out information in Service mode

↳ After starting up in the "RUN" switch position, set the service switch of the MA to the "MA" position.

↳ Now start one of the following terminal programs: e.g., BCL, RF, BPS Config.

Alternatively, you can also use the Windows tool "Hyperterminal".

↳ Start the program.

↳ Select the correct COM port (e.g., COM1) and set the interface as follows:

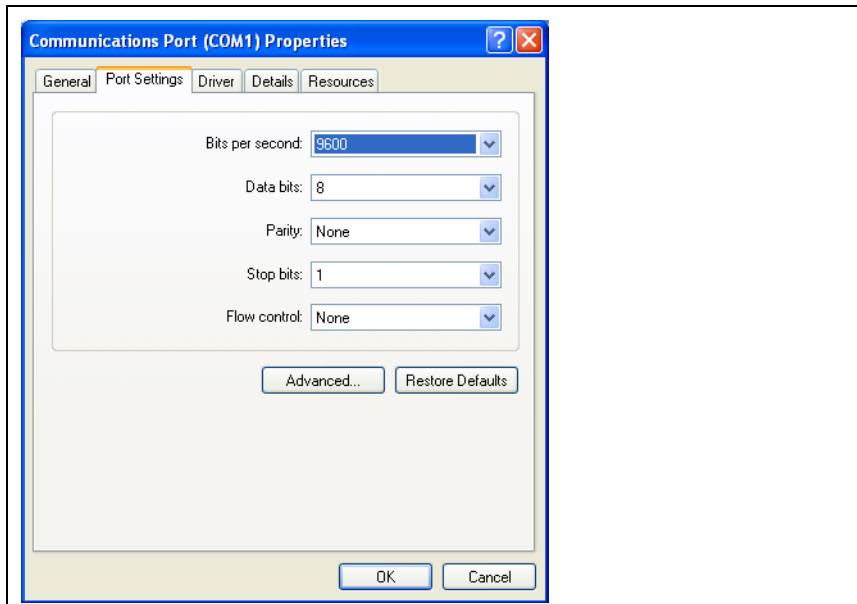

Figure 9.2: COM port settings



Notice!

Observe that STX, data, CR, LF framing must be set on the PC terminal program so that communication is possible with the connected Leuze device.

Commands

You can now call up information on the MA 238*i* by sending the following commands.

v	General service information.
s	Enable memory mode for the last frames.
l	The memory mode shows the last RX and TX frames for ASCII and fieldbus.

Table 9.1: Available commands

Information

Version	Version information.
Firmware date	Firmware date.

Table 9.2: General firmware information

Selected scanner	Currently selected Leuze device (selected via switch S4).
Gateway mode	Transparent or Collective mode.
Ring buffer fill level	Current fill level of the ring memory in Collective mode (ASCII->Fieldbus). 1024 bytes max.
Received ASCII Frames	Number of received ASCII frames.
ASCII Framing Error (GW)	Number of received framing errors.
Number of Received CTB's	Number of CTB commands.
Number of Received SFB's	Number of SFB commands.
Command-Buffer fill level	Current fill level of the ring memory in Command mode (fieldbus->ASCII). 1024 bytes max.
Number of received transparent frames	Number of received fieldbus frames without CTB/SFB.
Number of send fieldbus frames	Number of frames sent via the fieldbus.
Number of invalid commands	Number of invalid commands.
Number of ASCII stack send errors	Number of frames that the ASCII memory could not send.
Number of good ASCII send frames	Number of frames that the ASCII memory sent successfully.

Table 9.3: General gateway information

ND	Current status of ND bit.
W-Ack	Current status of W-Ack bit.
R-Ack	Current status R-Ack bit.
Data loss	Current status of data loss bit.
Ring buffer overflow	Current status of ring buffer overflow bit.
DEX	Current status of DEX bit.
BLR	Current status of BLR bit.

Table 9.4: Current states of the status and control bits

ASCII-Start-Byte	Currently configured start byte (dependent on switch position S4).
ASCII-End-Byte1	Currently configured stop byte 1 (dependent on switch position S4).
ASCII-End-Byte2	Currently configured stop byte 2 (dependent on switch position S4).
ASCII framing	Character length, parity, stop bit(s).
ASCII baud rate	Currently configured baud rate (dependent on switch position S4).
ASCII warm start status	Indicates whether the ASCII memory has detected and accepted a valid configuration.

Table 9.5: ASCII configuration

ECAT Input Data Length	Length of the data received (consumed data, default 8 bytes).
ECAT Output Data Length	Length of the data supplied (produced data, default 24 bytes).
Set IO Size Error(s)	Input/output size error.
Status Change Error(s)	Status change error.
Enable Control Status Change Error(s)	Activate control status change error output.
Local SDO Download Error(s)	Local error SDO download.
Status Indication(s)	Status display(s).

Table 9.6: MA 238*i* communication parameters

10 Telegram

10.1 Structure of the fieldbus telegram

All operations are performed by control and status bits. Two bytes of control information and two bytes of status information are available for this purpose. The control bits are a part of the output module and the status bits are a part of the input bytes. The data starts with the third byte.

If the actual data length is longer than the data length configured in the gateway, only part of the data is transmitted; the remaining data is lost. In this case, the DL (data loss) bit is set.

The following telegram structure is used between **PLC -> fieldbus gateway**:

7	6	5	4	3	2	1	0	
ND	Address 4	Address 3	Address 2	Address 1	Address 0	Broadcast	Command mode	Control byte 0
				CTB	SFB		R-ACK	Control byte 1
Data byte / parameter byte 0								Data
Data byte / parameter byte 1								
...								

This telegram structure is used between **fieldbus gateway -> PLC**:

7	6	5	4	3	2	1	0	
ND	B0	DL	BLR	DEX	SMA		W-ACK	Status byte 0
DLC7	DLC6	DLC5	DLC4	DLC3	DLC2	DLC1	DLC0	Status byte 1
Data byte / parameter byte 0								Data
Data byte / parameter byte 1								
...								

Only the data part with the corresponding frame (e.g., STX, CR & LF) is then transmitted between the fieldbus gateway and the Leuze end device. The two control bytes are processed by the fieldbus gateway.

The corresponding control and status bits and their meaning are specified in section 10.2 and section 10.3.

Further information on the broadcast control bytes and address bits 0 ... 4 can be found in chapter "Modular interfacing unit MA 3x (S4 switch position C)" on page 90.

10.2 Description of the input bytes (status bytes)

10.2.1 Structure and meaning of the input bytes (status bytes)

7	6	5	4	3	2	1	0	
ND	BO	DL	BLR	DEX	SMA		W-ACK	Status byte 0
DLC7	DLC6	DLC5	DLC4	DLC3	DLC2	DLC1	DLC0	Status byte 1
Data byte / parameter byte 0								Data
Data byte / parameter byte 1								
...								

Table 10.1: Structure of the input bytes (status bytes)

Bits of the input byte (status byte) 0

Bit no.	Designation	Meaning
0	W-ACK	Write-Acknowledge (write confirmation when using buffer)
2	SMA	Service mode active(service mode activated)
3	DEX	Data exist (data in transmit buffer)
4	BLR	Next block ready (new block ready)
5	DL	Data loss
6	BO	Buffer overflow
7	ND	New data only in Transparent mode

Bits of the input byte (status byte) 1

Bit no.	Designation	Meaning
0 ... 7	DLC0 ... DLC7	Data Length Code (length of the following user data)



Notice!

T-bit means toggle bit, i.e. this bit changes its state on each event ("0" → "1" or "1" → "0").

10.2.2 Detailed description of the bits (input byte 0)

Bit 0: Write-Acknowledge: W-ACK

This bit is only relevant for writing slave data in blocks, see chapter 11.1.2 (buffer data on RS 232). It toggles when data from the PLC are sent to the MA with CTB or SFB.

Input data	Description	Addr.	Data type	Value range	Default
W-ACK	<p>Write-Acknowledge (write confirmation) Write handshake</p> <p>Indicates that the data was successfully sent by the PLC to the gateway.</p> <p>Write-Acknowledge is indicated via this bit. The W-ACK bit is toggled by the fieldbus gateway whenever a transmit command has been successfully executed. This applies both for the transmission of data to the transmit buffer with the CTB command and for sending the transmit buffer contents with the SFB command.</p>	0.0	Bit	<p>0->1: Successfully written 1->0: Successfully written</p>	0

Bit 2: Service mode active: SMA

Input data	Description	Addr.	Data type	Value range	Default
SMA	<p>Service mode active (SMA)</p> <p>The SMA bit is set if the service switch is set to "MA" or "DEV", i.e. if the device is in either fieldbus gateway or Leuze device service mode. This is also indicated by a flashing PWR LED on the front side of the device. Upon changing to the normal operating mode "RUN", the bit is reset.</p>	0.2	Bit	<p>0: Device in operating mode 1: Device in service mode</p>	0h

Bit 3: Data exist: DEX

This bit is only relevant for reading slave data in Collective mode relevant, see chapter 11.1.1.

Input data	Description	Addr.	Data type	Value range	Default
DEX	<p>Data exist (data in transmit buffer)</p> <p>Indicates that further data is stored in the transmit buffer which is ready for transmission to the control. This flag bit is always set to high ("1") by the fieldbus gateway as long as data is in the buffer.</p>	0.3	Bit	<p>0: No data in the transmit buffer 1: Further data in the transmit buffer</p>	0h

Bit 4: Next block ready to transmit: BLR

This bit is only relevant for reading slave data in Collective mode relevant, see chapter 11.1.1.

Input data	Description	Addr.	Data type	Value range	Default
BLR	Next block ready to transmit (new block ready) The Block Ready toggle bit changes its state whenever the fieldbus gateway has removed received data from the receive buffer and registered it in the corresponding receive-data bytes. This signals to the master that the quantity of data indicated in the DLC bits to be present in the input data bytes originated in the data buffer and is current.	0.4	Bit	0->1: Data transmitted 1->0: Data transmitted	0

Bit 5: Data loss: DL

This bit is important for monitoring data transmission in Transparent and Collective mode.

Input data	Description	Addr.	Data type	Value range	Default
DL	Data loss (Data transmission monitoring) This bit is set until the device is reset (bit pattern see chapter 10.4 "RESET function / deleting memory") in case gateway data was not able to be sent to the PLC and was lost. Furthermore, this bit is set in case the configured data frame, e.g. 8 bit, should be smaller than the data to be transmitted to the PLC, e.g. bar code with 20 digits. In this case, the first 8 digits are transmitted to the PLC, the rest are truncated and are lost. In this process, the Data loss bit is also set.	0.6	Bit	0->1: Data loss	0

Bit 6: Buffer overflow: BO

Input data	Description	Addr.	Data type	Value range	Default
BO	Buffer overflow (buffer overflow) This flag bit is set to high ("1") when the buffer overflows. The bit is automatically reset when the buffer again has memory space available. While the BO bit is set, the RTS signal of the serial interface is deactivated. The memory size of the gateway for the data of both the PLC and the Leuze end device is 1 kByte.	0.6	Bit	0->1: Buffer overflow 1->0: Buffer o.k.	0

Bit 7: New data: ND

This bit is only relevant in Transparent mode.

Input data	Description	Addr.	Data type	Value range	Default
ND	New data (new data) This bit is toggled on each data set that is sent from the gateway to the PLC. This can be used to differentiate between multiple, identical data sets that are sent to the PLC.	0.7	Bit	0->1; 1->0: On each status change for new data	0

10.2.3 Detailed description of the bits (input byte 1)

Bit 0 ... 7: Data length code: DLC0 ... DLC7

Input data	Description	Addr.	Data type	Value range	Default
DLC0 ... DLC7	Data length code (number of user data in bytes) Stored in these bits is the number of user data bytes transmitted to the PLC which follow.	1.0 ... 1.7	Bit	1 _h (00001 _b) ... FF _h (00255 _b)	0h (00000b)

10.3 Description of the output bytes (control bytes)

10.3.1 Structure and meaning of the output bytes (control bytes)

	7	6	5	4	3	2	1	0	
	ND	Address 4	Address 3	Address 2	Address 1	Address 0	Broadcast	Command mode	Control byte 0
					CTB	SFB		R-ACK	Control byte 1
	Data byte 1								
	Data byte 2								Data
	...								

Table 10.2: Structure of the output bytes (control bytes)

Bits of the output byte (control byte) 0

Bit no.	Designation	Meaning
0	Command mode	Command mode
1	Broadcast	Broadcast (only relevant with a connected MA 3x)
2 ... 6	Address 0 .. 4	Address bits 0 .. 4 (only relevant with a connected MA 3x)
7	ND	New data

Bits of the output byte (control byte) 1

Bit no.	Designation	Meaning
0	R-ACK	Read-Acknowledge
2	SFB	Send data from transmit buffer
3	CTB	Copy to transmit-buffer

10.3.2 Detailed description of the bits (output byte 0)

Bit 0: Command mode: Command mode

Output data	Description	Addr.	Data type	Value range	Default
Command mode	Command mode This bit is used to activate Command mode. In Command mode, no data is sent by the PLC to the Leuze end device via the gateway. In Command mode, various bits that execute corresponding commands depending on the selected Leuze device can be set in the data- or parameter field. For further information, see chapter 11.1.3 "Command mode".	0.0	Bit	0: Default, transparent data transmission 1: Command mode	0

The following two control bits ("Bit 1: Broadcast: Broadcast" on page 48 and "Bits 2 ... 6: address bits 0 .. 4: address 0 .. 4" on page 48) are only relevant with a connected MA 3x. With other devices, these fields are ignored.

Bit 1: Broadcast: Broadcast

Output data	Description	Addr.	Data type	Value range	Default
Broadcast	Broadcast A broadcast only functions with a multiNet network connected via the MA 3x. If this bit is activated, the gateway automatically adds the broadcast command "00B" before the data. This is directed at all participants in the multiNet.	0.1	Bit	0: No broadcast 1: Broadcast	0

Bits 2 ... 6: address bits 0 .. 4: address 0 .. 4

Output data	Description	Addr.	Data type	Value range	Default
Address 0..4	Address bits 0 .. 4 As with the broadcast command, individual devices in the multiNet can also be addressed via the MA 3x. In this case, the corresponding address of the device precedes the data field telegram.	0.2 ... 0.6	Bit	00000: Addr. 0 00001: Addr. 1 00010: Addr. 2 00011: Addr. 3 ...	0

Bit 7: New data: ND

Output data	Description	Addr.	Data type	Value range	Default
ND	New data This bit is needed if several identical pieces of data are to be sent in sequence.	0.7	Bit	0->1; 1->0: On each status change for new data	0

10.3.3 Detailed description of the bits (output byte 1)

Bit 0: Read-Acknowledge: R-ACK

This bit is only relevant for writing slave data in blocks (Collective mode), see chapter 11.1.2.

Output data	Description	Addr.	Data type	Value range	Default
R-ACK	Read-Acknowledge (read confirmation) Toggle bit: Indicates to the fieldbus gateway that the "old" data has been processed and that new data can be received. At the end of a read cycle, this bit must be toggled in order to be able to receive the next data set. This toggle bit is switched by the master after valid received data has been read out of the input bytes and the next datablock can be requested. If the gateway detects a signal change in the R-ACK bit, the next bytes are automatically written from the receive buffer to the input data words and the BLR bit toggled. Further toggling erases the memory (to 00h).	1.0	Bit	0->1 or 1->0: Successfully written & ready for the next transmission	0

Bit 2: Send data from buffer: SFB

This bit is only relevant for writing slave data in blocks (Collective mode), see chapter 11.1.2.

Output data	Description	Addr.	Data type	Value range	Default
SFB	Send data from buffer (send data from the gateway transmit buffer to the RS 232) Toggle bit: changing this bit causes all data which was copied to the transmit buffer of the fieldbus gateway via the CTB bit to be transmitted to the RS 232 interface or the connected Leuze device.	1.2	Bit	0->1: Data to RS 232 1->0: Data to RS 232	0

Bit 3: Copy to transmit buffer: CTB

This bit is only relevant for writing slave data in blocks (Collective mode), see chapter 11.1.2.

Output data	Description	Addr.	Data type	Value range	Default
CTB	<p>Copy to transmit buffer (transmission data to transmit buffer)</p> <p>Toggle bit: Changing this bit writes the data from the PLC to the transmit buffer of the fieldbus gateway. This is used, for example, for long command strings which must be transmitted to the connected ident device.</p> <p>The CTB toggle bit is switched whenever transmit data is not to be sent directly via the serial interface, but instead transferred to the transmit buffer.</p>	1.3	Bit	<p>0->1: Data in buffer</p> <p>1->0: Data in buffer</p>	0



Notice!

The state change of the CTB bit signals the MA that the data is going into the buffer; therefore, it's essential to observe the order!

When the CTB is not used, the telegram (which fits in one cycle) is transmitted directly to the RS 232 interface. Please make sure it is complete!

10.4 RESET function / deleting memory

For many applications, it is helpful to be able to reset the MA buffer (in Collective mode) or status bits.

The following bit pattern can be transmitted from the PLC for this purpose (if >20 ms is pending):

```
Control byte 0:          10101010 (AAh)
Control byte 1:          10101010 (AAh)
OUT data byte 0/parameter byte 0:  AAh
OUT data byte 1/parameter byte 1:  AAh
```

This sets the memory or status/control bits to 00h.

Please observe that the data image may need to be updated by toggling in Collective mode.

11 Modes

11.1 Functionality of the data exchange

The fieldbus gateway has two different modes that can be selected via the PLC:

- **Transparent mode (standard setting)**

In Transparent mode, all data is sent 1:1 and directly by the serial end device to the PLC. It is not necessary to use status and control bits here. However, only data bytes possible for **one** transmission cycle are transmitted - all others are lost.

The distance between two successive telegrams (without frame) must be more than 20ms, since there is otherwise no clear separation between them.

ASCII characters are typically expected as data content; under certain circumstances, the MA therefore detects different control characters as invalid characters in the data range and truncates them. At 00_n in the data range, the MA cuts the telegram off because unnecessary bytes are also filled with 00_n .

- **Collective mode**

In Collective mode, the data of the serial end device is stored temporarily in the fieldbus gateway by toggling the CTB bit and is not sent to the PLC in blocks until prompted to do so by the PLC.

On the PLC, a status bit (DEX) then signals that new data is ready for retrieval. This data is then read out from the fieldbus gateway in blocks (toggle bit).

In order to distinguish between the individual telegrams on the PLC, in Collective mode the serial frame is sent to the PLC in addition to the data.

The size of the buffer is 1 kByte.



Notice!

In Collective mode, the CTB and SFB bits are needed for communication handling via the buffer. Telegrams that can also be completely transmitted in one cycle in Collective mode (including data frame) go directly through. If PLC data is provided and transferred without a state change of the CTB bit, it goes directly to the RS 232 interface with the set telegram data length. Incomplete (incl. data frame) or faulty telegrams can cause error messages in the connected device!

Combination with the Command mode is possible.

Data exchange in blocks must be programmed on the PLC.

11.1.1 Reading slave data in Collective mode (gateway -> PLC)

If the Leuze device transmits data to the fieldbus gateway, the data is stored temporarily in a buffer. The PLC is signaled via the "DEX" bit that data is ready for retrieval in the memory. Data is not automatically transmitted.

If no further user data is present in the MA 238*i* ("DEX" bit = "0"), the "R-ACK" bit must be toggled once as read confirmation to release data transmission for the next read cycle.

If the buffer still contains more data ("DEX" bit = 1), the next remaining user data present in the buffer is transmitted by toggling the "R-ACK" control bit. This process is to be repeated until the "DEX" bit returns to "0"; all data has then been removed from the buffer. "R-ACK" must be toggled here again once more as a terminating read confirmation in order to release data transmission for the next read cycle.

Used status and control bits:

- DLC
- BLR
- DEX
- R-ACK

11.1.2 Writing slave data in Collective mode (PLC -> gateway)

Writing in blocks

The data sent by the master to the slave is first collected in a "transmit buffer" by setting the "CTB" bit (**C**opy to **t**ransmit **b**uffer). Please observe that data provided is transmitted directly by toggling the bit.

The data is then sent in the order received from the buffer to the connected Leuze device via the serial interface with the command: "SFB" (**S**end data **f**rom transmit **b**uffer). Please don't forget the suitable data frame!

Afterward, the buffer is again empty and can be written with new data.



Notice!

With this function, it is possible to temporarily store longer data strings in the gateway independent of how many bytes the used fieldbus can transmit at once. With this function, longer PT sequences or RFID write sequences, for example, can be transmitted, since the connected devices can, in this way, receive their commands (e.g., PT or W) in a continuous string. The respective frame (STX CR LF) is needed to differentiate between the individual telegrams.

Used status and control bits:

- CTB
- SFB
- W-ACK

If PLC data is provided and transferred without a state change of the CTB bit, it goes directly to the RS 232 interface with the set telegram data length. Incomplete (incl. data frame) or faulty telegrams can cause error messages in the connected device!

Examples for the activation of a Leuze device

In the data part (starting at byte 2) of the telegram to the gateway, a "+" (ASCII) is sent for activation.

This means that the hex value "2B" (corresponds to a "+") is to be entered in control or output byte 2. To deactivate the reading gate, a "2D" (hex) must be used instead (corresponds to a "-" ASCII).

	7	6	5	4	3	2	1	0	
	ND	Address 4	Address 3	Address 2	Address 1	Address 0	Broadcast	Command mode	Control byte 0
					CTB	SFB		R-ACK	Control byte 1
	Data byte 1								Data
	Data byte 2								
	...								
	7	6	5	4	3	2	1	0	
	0	0	0	0	0	0	0	0	Output byte 0
	0	0	0	0	0	0	0	0	Output byte 1
	0	0	0	0	0	0	B	2	Output byte 2
	0	0	0	0	0	0	0	0	Output byte 3

Collective mode sequence diagram

Send long online commands to the DEV, read RS 232 answer from DEV

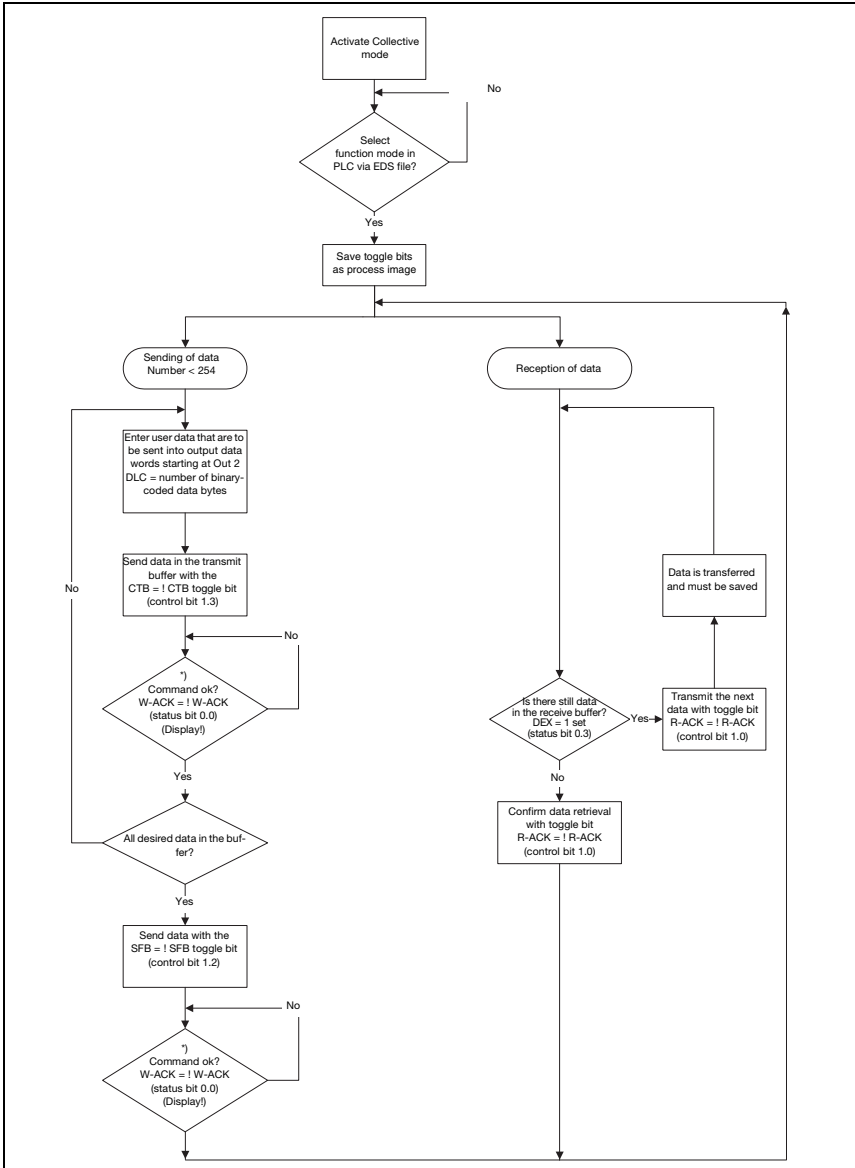

Figure 11.1: Data transmission scheme with long online commands

11.1.3 Command mode

One specific feature is the so-called Command mode, which is defined via the output control byte 0 (bit 0) ... and enables the control of the connected device per bit.

If the command mode is activated (command mode = 1), no data is sent by the PLC to the Leuze end device via the gateway. The data from the MA to the PLC is transmitted in the selected operating mode (Transparent/Collective).

With the Command mode, it is possible to set various device-specific bits in the data- or parameter field that execute the corresponding serial commands (e.g., v, +, -, etc.). If, for example, the version of the Leuze end device is to be queried, the corresponding bit is to be set so that a "v" is sent to the Leuze device with the <STX> v <CR> <LF> frame.

The Leuze end device also answers the gateway with data (e.g. bar code content, NoRead, device version, etc.) in response to most commands. The answer is immediately passed on to the PLC by the gateway.



Notice!

The parameters available for the individual Leuze devices are listed in chapter 16. Command mode cannot be used with hand-held scanners.

Examples for the activation of a Leuze device

In Command mode, control or output byte 0.0 is to be set for activating the Command mode. Only the corresponding bit (control or output byte 2.1) then needs to be set for activating and deactivating the reading gate.

7	6	5	4	3	2	1	0	
0	0	0	0	0	0	0	1	Output byte 0
0	0	0	0	0	0	0	0	Output byte 1
0	0	0	0	0	0	1	0	Output byte 2
0	0	0	0	0	0	0	0	Output byte 3

Command mode sequence diagram

Set control byte 0, bit 0.0 to 1

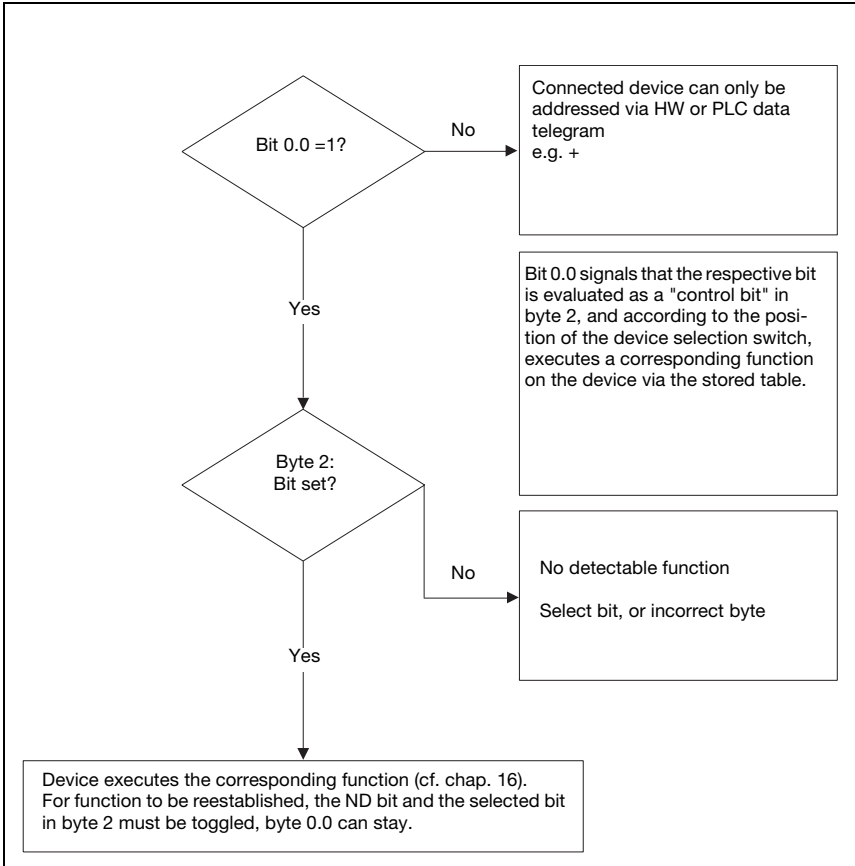

Figure 11.2: Execution of command after activation of the Command mode

Triggering the ident devices and reading the data

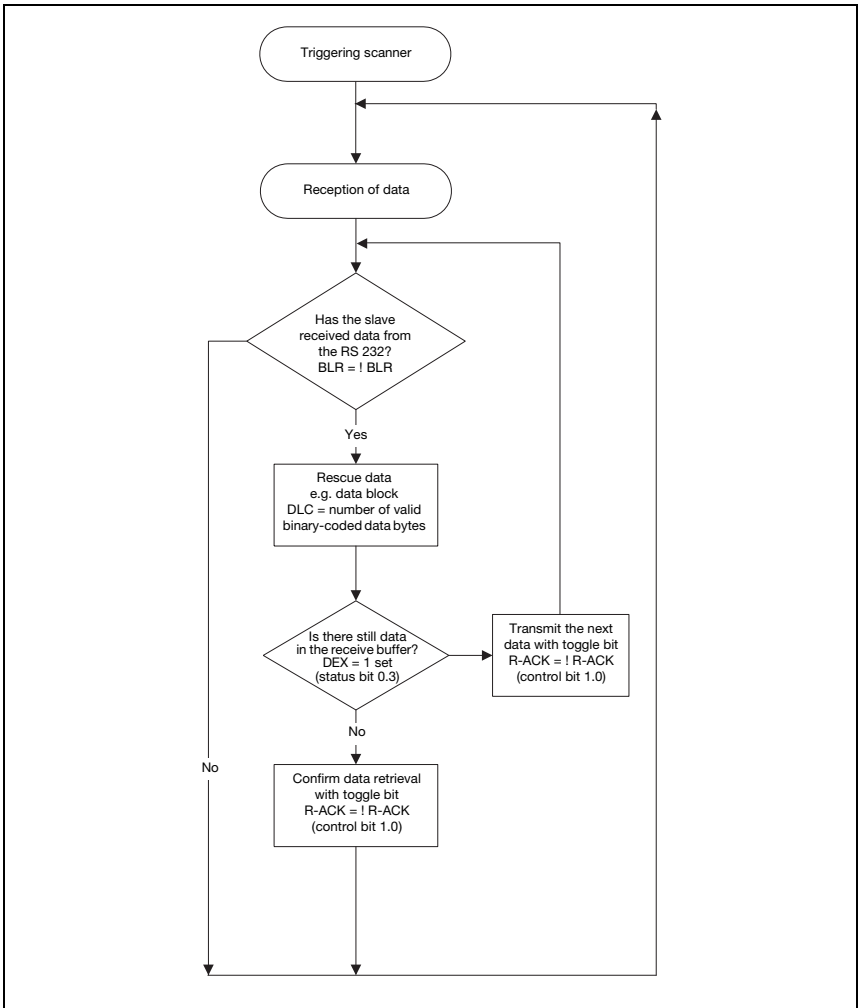

Figure 11.3: Activating DEV and reading data



Notice!

Further information on fieldbus telegram structure can be found in chapter 10.1. A specification of all usable commands can be found in chapter "Specifications for Leuze end devices" on page 77.

12 Commissioning and configuration

12.1 Measures to be performed prior to the initial commissioning

- ↳ Before commissioning, familiarize yourself with the operation and configuration of the MA 238*i*.
- ↳ **Before connecting the supply voltage**, recheck all connections and ensure that they have been properly made.

The Leuze device must be connected to the internal RS 232 device interface.

Connecting the Leuze device

- ↳ Open the housing of the MA 238*i* and lead the corresponding device cable (see chapter 14.6) through the middle threaded opening.
- ↳ Connect the cable to the internal device interface (X30, X31 or X32, see chapter 7.5.1).
- ↳ Use rotary switch S4 (see chapter 8.2.5) to select the connected device.
- ↳ Now screw the PG cable gland into the threaded opening to provide strain relief and ensure protection class IP 65.
- ↳ Finally, close the housing of the MA 238*i*.



Attention!

Only then may the supply voltage be applied.

Upon startup of the MA 238*i*, the device selection switch is queried and the gateway automatically sets itself to the Leuze device.

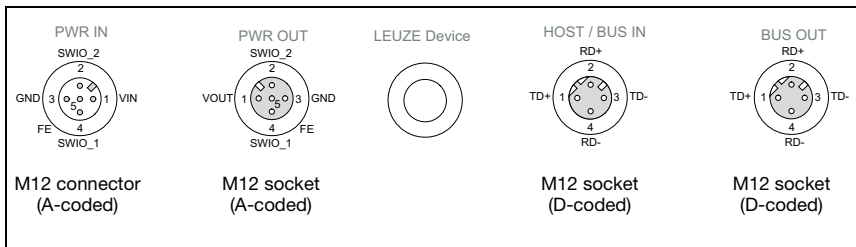

Figure 12.1: Connections of the MA 238*i* seen from below, device on mounting plate

- ↳ Check the applied voltage. It must be in the range between +18V ... 30VDC.

Connecting functional earth FE

- ↳ Ensure that the functional earth (FE) is connected correctly.

Unimpaired operation is only guaranteed when the functional earth is connected properly. All electrical disturbances (EMC couplings) are discharged via the functional earth connection.

On delivery, the SWIO 1/2 are connected in parallel on PWR IN/OUT. This connection can be separated with a jumper.

12.1.1 Connecting the power supply and the bus cable

- ↳ Ideally, use the ready-made cables listed in chapter 14.4.3 to connect the gateway to the power supply via the **PWR IN** connection.
- ↳ The ready-made cables listed in chapter 14.5.4 are preferred for connecting the gateway to the fieldbus via the **HOST / BUS IN** connection.
- ↳ If applicable, use the **BUS OUT** connection if you would like to construct a network with linear topology.

12.2 Starting the device

- ↳ Apply the supply voltage +18 ... 30VDC (typ. +24VDC); the MA 238*i* starts up. The PWR LED displays that it is ready for operation.

12.3 MA 238*i* in the EtherCAT system

12.4 Starting the MA 238*i* in the EtherCAT system

During starting up, the gateway runs through different states which are explained in brief in the following.

INIT

The MA 238*i* initializes itself. No direct communication between the master and MA 238*i* is possible. The EtherCAT master will transit the MA 238*i* step by step into the "operational" state.

In the status change from "INIT" to "PREOP", the TwinCAT or master writes the so-called EtherCAT address (=station address) to the respective register of the EtherCAT slave controller (here: MA 238*i*). This EtherCAT address is typically specified in relation to the position, i.e., the master's address is 1000, the first slave's address is 1001, etc. This is also called the auto-increment method.

PRE-OPERATIONAL

The master and the MA 238*i* exchange application-specific initializations and device-specific parameters. In the PRE-OPERATIONAL state, configuration is initially possible via SDOs only.

SAFE-OPERATIONAL

The "Start Input Update" command puts the gateway into the "Safe-Operational" state. The master produces output data, but input data are not considered. This means the MA 238*i* does not return output data (=PLC input data) in SAFEOP. The gateway does not process input process data (=PLC output data). Mailbox communication via CoE services is possible.

OPERATIONAL

The "Start Output Update" command puts the gateway into the OPERATIONAL state. In this state, the MA 238*i* supplies valid input data and the master valid output data. After the MA 238*i* has detected the data received via the process data service, the state transition is confirmed by the MA 238*i*. If the activation of the output data was not possible, the gateway remains in the SAFE OPERATIONAL state and outputs an error message.

12.5 CANopen over EtherCAT

EtherCAT provides the communication mechanisms described below. In this context, the SDO accesses to the online dictionary via CoE (CANopen over EtherCAT) are carried out via mailbox services. PDO services via CoE mailboxes are not supported.

- Object index
- PDO, process data object
- SDO, service data object
- NMT, network management

Master and slave must be located in the same EtherCAT network.

12.5.1 Device profile

The device profile describes the application parameters and the functional behavior of the MA 238*i*. For EtherCAT, one does not specify individual device profiles for device classes. Instead, simple interfaces for existing device profiles are provided.

12.5.2 Device description file

For EtherCAT, all process data and parameters are described in objects. The compilation of all process data and parameters of the gateway - the object directory - is stored in a so-called ESI file (EtherCAT Slave Information).

The ESI file contains all objects with index, sub-index, name, data type, default value, minimum and maximum, and access possibilities. That means the ESI file describes the entire functionality of the MA 238*i*, and it is possible to adjust both the communication of the gateway with the control and the RS 232 interface.

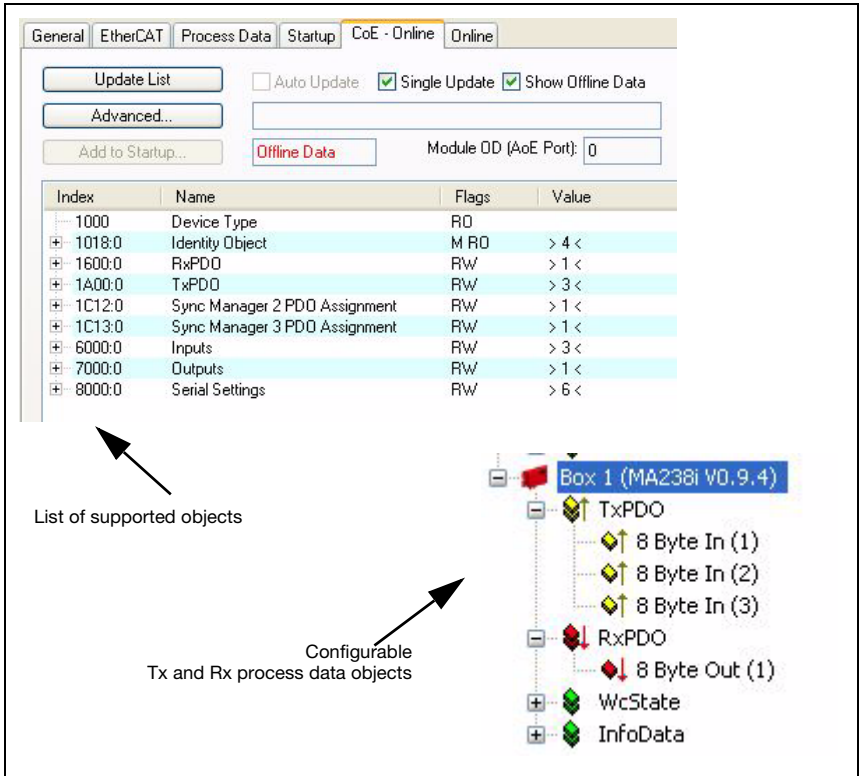

Figure 12.2: Configuration options

The ESI file has the name MA 238*i*.xml and is available for download on the Leuze home page.

Vendor ID for the MA 238*i*

The Vendor ID assigned by Leuze electronic for the MA 238*i* is 121_h = 289_d.

12.5.3 Object index

The object directory of the MA 238*i* is the compilation of all process data and parameters of the MA.

The following overview table shows all objects supported by the MA 238*i*.

Object address in hex	EtherCAT-specific object area
1000	Device Type
1018:0	Identity Object (contains general information regarding the device)
1600:0	RxPDO1
1A00:0	TxPDO1
1C12:0	Sync Manager 2 PDO Assignment
1C13:0	Sync Manager 3 PDO Assignment
6000:0	Inputs (Input Data, 8 bytes by 8 bytes (Rx))
7000:0	Outputs (Output Data, 8 bytes by 8 bytes (Tx))
8000:0	Serial Settings (RS 232)

Afterwards, you will find the respective detailed descriptions of the individual objects.

12.5.3.1 Object 1000_h Device Type

The object describes the MA 238*i* device type.

Index (hex)	Sub-index (hex)	Name	Data type	Access	Value range			Remark
					Minimum	Maximum	Default	
1000	--	Device type	u32	ro	--	--	0000	

12.5.3.2 Object 1018_h Identity Object

This object contains general specifications about the MA 238*i*.

Index (hex)	Sub-index (hex)	Name	Data type	Access	Value range			Remark
					Minimum	Maximum	Default	
1018	01	Vendor ID	u32	ro	--	--	121 _h	Manufacturer ID number
	02	Product Code	u32	ro	--	--	F1 _h	
	03	Revision	u32	ro	--	--	--	
	04	Serial Number	u32	ro	--	--	--	

The Vendor ID assigned by Leuze electronic for the MA 238*i* is 121_h = 289_d.

12.5.3.3 Object 1600_n RxPDO

The object describes the Rx process data object.

Index (hex)	Sub-index (hex)	Name	Data type	Access	Value range			Remark
					Minimum	Maximum	Default	
1600	--	RxPDO	u32	rw	--	--	--	
	01	8 Byte OUT (1)	u32	rw	--	--	0x7000:01,64	
	1E	8 Byte OUT (30)	u32	rw	--	--	--	
	1F	8 Byte OUT (31)	u32	rw	--	--	--	
	20	8 Byte OUT (32)	u32	rw	--	--	--	

12.5.3.4 Object 1A00_n TxPDO

The object describes the Tx process data objects.

Index (hex)	Sub-index (hex)	Name	Data type	Access	Value range			Remark
					Minimum	Maximum	Default	
1A00	--	TxPDO	u32	rw	--	--	--	
	01	8 Byte In (1)		rw	--	--	0x6000:01,64	
	02	8 Byte In (2)		rw	--	--	0x6000:02,64	
	03	8 Byte In (3)		rw	--	--	0x6000:03,64	
	04	8 Byte In (4)		rw	--	--	--	
	05	8 Byte In (5)		rw	--	--	--	
	06	8 Byte In (6)		rw	--	--	--	
	1F	8 Byte In (31)		rw	--	--	--	
	20	8 Byte In (20)		rw	--	--	--	

12.5.3.5 Object 1C12 Sync Manager 2 PDO Assignment

The object assigns the Rx process data objects to Sync Manager 2.

Index (hex)	Sub-index (hex)	Name	Data type	Access	Value range			Remark
					Minimum	Maximum	Default	
1C12	--	Sync Manager 2 PDO Assignment	u32	rw	--	--	--	
	01	SubIndex 001		rw	--	--	0x1600 (5632)	

12.5.3.6 Object 1C13 Sync Manager 3 PDO Assignment

The object assigns the Tx process data objects to Sync Manager 3.

Index (hex)	Sub-index (hex)	Name	Data type	Access	Value range			Remark
					Minimum	Maximum	Default	
1C13	--	Sync Manager 3 PDO Assignment	u32	rw	--	--	--	
	01	SubIndex 001		rw	--	--	0x1A00 (6656)	

12.5.3.7 Object 6000 Inputs

The object describes the input data of the MA 238*i*, which is transmitted cyclically, 8 bytes by 8 bytes (Rx).

Index (hex)	Sub-index (hex)	Name	Data type	Access	Value range			Remark
					Minimum	Maximum	Default	
6000	--	Inputs	u32	rw		--		
	01	8 Byte Inputs (1)		ro			00 00 00 00 00 00 00 00	
	02	8 Byte Inputs (2)		ro			00 00 00 00 00 00 00 00	
	03	8 Byte Inputs (3)		ro			00 00 00 00 00 00 00 00	
	04	8 Byte Inputs (4)		ro				
	05	8 Byte Inputs (5)		ro				
	06	8 Byte Inputs (6)		ro				
	07	8 Byte Inputs (7)		ro				
	08	8 Byte Inputs (8)		ro				
	1F	8 Byte Inputs (31)		ro				
	20	8 Byte Inputs (32)		ro				

12.5.3.8 Object 7000 Outputs

The object describes the output data of the MA 238*i*, which is transmitted cyclically, 8 bytes by 8 bytes (Tx).

Index (hex)	Sub-index (hex)	Name	Data type	Access	Value range			Remark
					Minimum	Maximum	Default	
7000	--	Outputs	u32	rw	--	--		
	01	8 Byte Outputs (1)		ro			00 00 00 00 00 00 00 00	
	02	8 Byte Outputs (2)		ro				
	03	8 Byte Outputs (3)		ro				
	04	8 Byte Outputs (4)		ro				
	1E	8 Byte Outputs (30)		ro				
	1F	8 Byte Outputs (31)		ro				
	20	8 Byte Outputs (32)		ro				

12.5.3.9 Object 8000 Serial Settings

The object describes the serial RS 232 settings of the MA 238*i*.

Index (hex)	Sub-index (hex)	Name	Data type	Access	Value range			Remark
					Minimum	Maximum	Default	
8000	--	Serial Settings	u32	rw	--	--		
	01	Data Mode	u32	rw	--	--	Transparent Mode (0)	
	02	Use Rotary Switch	u32	rw	--	--	Use Rotary Switch (1)	
	03	Baud Rate	u32	rw	--	--	9600 Baud (96)	
	04	Data Bits	u32	rw	--	--	8 Data Bits (8)	
	05	Parity	u32	rw	--	--	None (1)	
	06	Stop Bits	u32	rw	--	--	1 Stop Bit (1)	

12.6 Setting the read parameters on the Leuze device

Commissioning the Leuze device

To commission a read station, you must prepare the Leuze device on the MA 238*i* for its reading task. Communication with the Leuze device occurs via the service interface.



Notice!

For further information on connecting and using the service interface, see chapter 9 "Configuration".

↳ To do this, connect the Leuze device to the MA 238*i*.

Depending on the Leuze device, this occurs either via a connection cable (accessory no.: KB 031-1000) or directly on the MA 238*i*. The service connector and corresponding switches can be accessed with the housing cover open.

↳ Select the "DEV" service switch position.

Connect the service interface; call up the terminal program

↳ Connect your PC to the service connector via the RS 232 cable.

↳ On the PC, call up a terminal program (e.g., BCL-Config) and check whether the interface (COM 1 or COM 2) to which you have connected the MA 238*i* is set to the following Leuze standard setting: 9600 baud, 8 data bits, no parity, 1 stop bit and STX, data, CR, LF.

You can download the config. tool from www.leuze.com for BCL, RFID, etc.

In order to communicate with the connected Leuze device, the **STX, data, CR, LF** framing must be set on the PC terminal program, as the Leuze device is preconfigured ex works for this frame character.

STX (02h):	Prefix 1
CR (0Dh):	Postfix 1
LF (0Ah):	Postfix 2

Operation

↳ Switch the MA 238*i* to switch position "RUN" (operation).

The Leuze device is now connected to the fieldbus. Activation of the Leuze device can now occur via the switching input on the MA 238*i*, via the process data word Out bit 1 (bit 0.2) or by transmitting a "+" command to the Leuze device (see chapter 16 "Specifications for Leuze end devices"). For further information on the fieldbus transmission protocol, see see chapter 10 "Telegram".

Reading out information in service mode

↳ Set the service switch of the gateway to switch position "MA" (gateway).

↳ Send a "v" command to call up all service information of the MA 238*i*.

An overview of the available commands and information can be found in chapter "Reading out information in Service mode" on page 40.

12.6.1 Specific feature for the use of hand-held scanners (bar code and 2D devices, combi devices with RFID)



Notice!

A description of the device configuration and the required codes can be found in the respective documentation at www.leuze.com. Cable-connected hand-held scanners on the MA 238*i*

All hand-held scanners and mobile combi devices available in the Leuze electronic product line can be used with the corresponding connection cable.

When using the MA 238*i*, the voltage supply of the hand-held scanner (4.75 ... 5.25VDC/ at 1 A) can be connected to the interface by means of a cable via the 9-pin Sub-D connector (voltage on PIN 9). The corresponding cable is to be selected for the respective hand-held scanner and ordered separately. The 9-pin Sub-D cable (KB JST-HS-300, part no. 50113397) is connected to this cable, which is connected to the MA 238*i*. This cable must also be ordered separately.

In this example, triggering occurs by means of a trigger button on the hand-held scanner.



Notice!

When using third-party devices, check the pin assignment and interface settings without fail and adjust them if necessary.

12.6.1.1 Wireless hand-held scanners on the MA 238i

All wireless hand-held scanners and mobile combi devices available in the Leuze electronic product line can be used with the corresponding connection cable via the base station.

A 230VAC connection (socket) is usually necessary for the charging station. Here, a data connection of the charging station is established with the MA 238i. The corresponding cable is to be selected for the respective hand-held scanner and ordered separately. The 9-pin Sub-D cable (KB JST-HS-300, part no. 50113397) is connected to this cable, which is connected to the MA 238i. This cable must also be ordered separately.

In this example, triggering occurs by means of a trigger button on the hand-held scanner. The following codes for configuring the devices are necessary for these devices as well.

12.6.2 Specific features in the operation of an RFM/RFI

When using the MA 238i in connection with an RFID device, we recommend a data width of at least 24 bytes to be able to transmit information to or from the reader in a telegram.

Shown here is a sample telegram for a write command in combination with an RFID device.



Notice!

Also note that all characters which are sent to a transponder are hex-encoded ASCII characters. Each of these (hexadecimal) characters is, in turn, to be handled as an individual ASCII character and converted to hexadecimal format for transmission via the fieldbus.

Example:

7	6	5	4	3	2	1	0	
00	00	00	00	00	00	00	00	Control byte 0
00	00	00	00	00	00	00	00	Control byte 1
34	35	31	31	30	35	30	57	Data
00	00	34	37	33	37	35	36	

HEX	57	30	35	30	31	31	35	34	36	35	37	33	37	34
CHAR	W	0	5	0	1	1	5	4	6	5	7	3	7	4
Plain text	T e s t													

13 Diagnostics and troubleshooting

If problems should occur during commissioning of the MA 238*i* you can refer to the following table. Typical errors and their possible causes are described here as well as tips for their elimination.

13.1 General causes of errors

Error	Possible error causes	Measures
No data to the PLC	Device setting incorrect.	Adjust device settings (data protocol, baud rate, etc.).
No data sporadically and/or the device "stalls"	Problems with the voltage supply.	Check voltage range, supply separately if needed.
Data loss (DL bit)	Data telegram longer than the bus telegram in bus cycle/memory size.	Increase in bus telegram length. Toggle out data earlier.
Data in the RS 232 instead of in the buffer	Incorrect order.	Correct order: Provide data, toggle CTB.
PWR status LED on the circuit board		
Off	No supply voltage connected to the device. Hardware error.	Check supply voltage. Send the device to customer service.
Green/orange, flashing	Device in boot mode.	No valid firmware, send device to customer service.
Continuous orange light	Device error.	Send the device to customer service.
	Firmware update failed.	
STATUS LED on the housing (see figure 5.1 on page 19)		
Red continuous light	Configuration error.	Check interface.
PWR LED on the housing (see figure 5.1 on page 19)		
Off	No supply voltage connected to the device.	Check supply voltage.
Green, flashing	SERVICE active.	Service switch on RUN.
Red, flashing	Incorrect baud rate / address.	Check switch settings.
		Check baud rate or address.
Red continuous light	Device error.	Send the device to customer service.
L / A LEDs on the housing (see figure 5.1 on page 19)		
Off	No connection	Check wiring/IP address.

Table 13.1: General causes of errors

13.2 Interface errors

Error	Possible error causes	Measures
No communication via EtherCAT interface STATUS continuous red light LED	Incorrect wiring.	Check wiring.
	Different protocol settings.	Check protocol settings.
	Protocol not released.	Activate TCP/ IP or UDP.
Sporadic errors at the EtherCAT interface	Incorrect wiring.	Check wiring. In particular, check wire shielding. Check the cable used.
	Effects due to EMC.	Check shielding (shield covering in place up to the clamping point). Check grounding concept and connection to functional earth (FE). Avoid EMC coupling caused by power cables laid parallel to device lines.
	Overall network expansion exceeded.	Check max. network expansion as a function of the max. cable lengths.

Figure 13.1: Interface error



Notice!

Please use **chapter 13 as a master copy** should servicing be required.

Cross the items in the "Measures" column which you have already examined, fill out the following address field and fax the pages together with your service contract to the fax number listed below.

Customer data (please complete)

Device type:	
Company:	
Contact partner / department:	
Phone (direct):	
Fax:	
Street / No:	
ZIP code/City:	
Country:	

Leuze Service fax number:

+49 7021 573 - 199

14 Type overview and accessories

14.1 Part number code

MA 2xx i

Interface	i =	Integrated fieldbus technology
	04	PROFIBUS DP
	08	Ethernet TCP/IP
	35	CANopen
	38	EtherCAT
	48	PROFINET RT
	55	DeviceNet
	58	EtherNet/IP
	MA	Modular interfacing unit

14.2 Type overview

Type designation	Description	Description
MA 204 <i>i</i>	PROFIBUS gateway	50112893
MA 208 <i>i</i>	Ethernet TCP/IP gateway	50112892
MA 235 <i>i</i>	CANopen gateway	50114154
MA 238 <i>i</i>	EtherCAT gateway	50114155
MA 248 <i>i</i>	PROFINET-IO RT gateway	50112891
MA 255 <i>i</i>	DeviceNet gateway	50114156
MA 258 <i>i</i>	EtherNet/IP gateway	50114157

Table 14.1: Type overview MA 2xx*i*

14.3 Accessory connectors

Type designation	Description	Description
KD 095-5A	M12 socket for voltage supply	50020501
KS 095-4A	M12 connector for SW IN/OUT	50040155
D-ET1	RJ45 connector for user-configuration	50108991
S-M12A-ET	Connector, axial, M12 connector, D-coded, terminals	50112155

Table 14.2: Connectors for the MA 238*i*

14.4 Accessory ready-made cables for voltage supply

14.4.1 Contact assignment of PWR connection cable

PWR IN (5-pin socket, A-coded)			
<p>PWR IN SWIO_2 VIN 1 3 GND 4 FE SWIO_1 M12 socket (A-coded)</p>	Pin	Name	Core color
	1	VIN	brown
	2	SWIO_2	white
	3	GND	blue
	4	SWIO_1	black
	5	FE	gray
Thread	FE	bare	

PWR OUT (5-pin connector, A-coded)			
<p>PWR OUT SWIO_2 GND 3 1 VOUT 4 FE SWIO_1 M12 connector (A-coded)</p>	Pin	Name	Core color
	1	VOUT	brown
	2	SWIO_2	white
	3	GND	blue
	4	SWIO_1	black
	5	FE	gray
Thread	FE	bare	

14.4.2 Specifications of the cables for voltage supply

Operating temperature range	in rest state:	-30°C ... +70°C
	in motion:	5°C ... +70°C
Material	sheathing:	PVC
Bending radius	>	50mm

14.4.3 Order codes of the cables for voltage supply

Type designation	Description	Part no.
K-D M12A-5P-5m-PVC	M12 socket for PWR, axial plug outlet, open cable end, cable length 5m	50104557
K-D M12A-5P-10m-PVC	M12 socket for PWR, axial plug outlet, open cable end, cable length 10m	50104559

Table 14.3: PWR cables for the MA 238*i*

14.5 Accessory ready-made cables for bus connection

14.5.1 General information

- Cable KB ET... for connecting to EtherCAT via M12 connector
- Standard cable available in lengths from 2 ... 30m
- Special cables on request

14.5.2 M12 contact assignments-Ethernet connection cable KB ET...

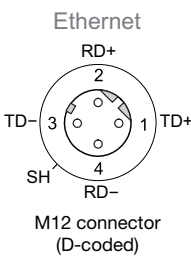
M12 EtherNet connection cable (4-pin connector, D-coded, on both sides)			
	Pin	Name	Core color
	1	TD+	yellow
	2	RD+	white
	3	TD-	orange
	4	RD-	blue
	SH (thread)	FE	bare

	Core color
	WH
	YE
	BU OG
Conductor class: VDE 0295, EN 60228, IEC 60228 (class 5)	

Figure 14.1: Cable structure of Industrial Ethernet connection cable

14.5.3 Technical data M12 Ethernet connection cable KB ET...

Operating temperature range in rest state: -50°C ... +80°C
 in motion: -25°C ... +80°C
 in motion: -25°C ... +60°C (when used with drag chains)

Material cable sheath: PUR (green), wire insulation: PE foam,
 free of halogens, silicone and PVC

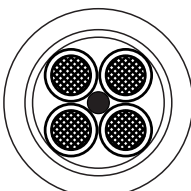
Bending radius > 65mm, suitable for drag chains

Bending cycles > 10⁶, perm. acceleration < 5m/s²

14.5.4 Order code M12 Ethernet connection cable KB ET...

Type designation	Description	Part no.
M12 connector for BUS IN, axial connector, open cable end		
KB ET - 1000 - SA	Cable length 1 m	50106738
KB ET - 2000 - SA	Cable length 2 m	50106739
KB ET - 5000 - SA	Cable length 5 m	50106740
KB ET - 10000 - SA	Cable length 10 m	50106741
M12 connector for BUS IN to RJ-45 connector		
KB ET - 1000 - SA-RJ45	Cable length 1 m	50109879
KB ET - 2000 - SA-RJ45	Cable length 2 m	50109880
KB ET - 5000 - SA-RJ45	Cable length 5 m	50109881
KB ET - 10000 - SA-RJ45	Cable length 10 m	50109882
M12 plug + M12 plug for BUS OUT to BUS IN		
KB ET - 1000 - SSA	Cable length 1 m	50106898
KB ET - 2000 - SSA	Cable length 2 m	50106899
KB ET - 5000 - SSA	Cable length 5 m	50106900
KB ET - 10000 - SSA	Cable length 10 m	50106901

Table 14.4: Bus connection cable for the MA 238*i*

14.6 Accessory ready-made cables for connecting Leuze Ident devices

14.6.1 Order codes for the device connection cables

Type designation	Description	Part no.
KB JST-3000	MA 31, BCL 90, IMRFU-1(RFU), cable length 3m	50115044
KB JST-HS-300	Hand-held scanner, cable length 0.3m	50113397
KB JST-M12A-5P-3000	BPS 8, BCL 8, cable length 3m	50113467
KB JST-M12A-8P-Y-3000	LSIS 4x2i, cable length 3m	50113468
KB JST-M12A-8P-3000	LSIS 122, LSIS 222, cable length 3m	50111225
K-D M12A-5P-5m-PVC	Voltage supply, cable length 5m	50104557
K-D M12A-5P-10m-PVC	Voltage supply, cable length 10m	50104559
K-DS M12A-MA-5P-3m-S-PUR	ODS 96B with RS 232	50115049
K-DS M12A-MA-8P-3m-S-PUR	ODSL 30/D 232-M 12	50115050
K-DS M12A-MA-5P-3m-1S-PUR	Konturflex Quattro RSX	50116791
KB 500-3000-Y	BCL 500i, cable length 3m	50110240
KB 301-3000-MA200	BCL 300i, cable length 3m	50120463

Table 14.5: Device connection cables for the MA 238*i*



Notice!

The BCL 22 devices with JST connector, RFM xx and RFI xx can be connected directly with the injection molded device cable.

14.6.2 Contact assignment for the device connection cables

K-D M12A-5P-5000/10000 connection cable (5-pin with molded connector), open cable end		
	Pin	Core color
	1	brown
	2	white
	3	blue
	4	black
	5	gray

KB JST 3000 (RS 232 connection cable, JST pin strip 10-pin, open cable end)		
Signal	Core color	JST 10-pin
TxD 232	red	5
RxD 232	brown	4
GND	orange	9
FE	shield	10

15 Maintenance

15.1 General maintenance information

The MA 238*i* does not require any maintenance by the operator.

15.2 Repairs, servicing

Repairs to the device must only be carried out by the manufacturer.

 *Contact your Leuze distributor or service organization should repairs be required.
The addresses can be found on the inside of the cover and on the back.*



Notice!

When sending devices to Leuze electronic for repair, please provide an accurate description of the error.

15.3 Disassembling, packing, disposing

Repacking

For later reuse, the device is to be packed so that it is protected.



Notice!

Electrical scrap is a special waste product! Observe the locally applicable regulations regarding disposal of the product.

16 Specifications for Leuze end devices

Serial interface and Command mode

The corresponding Leuze end device can be selected while configuring the fieldbus gateway (see chapter 9 "Configuration").

The exact specifications for the individual Leuze end devices can be found in the following sections and in the device description.

The corresponding serial command is sent to the Leuze end device in Command mode. To send the corresponding command to the RS 232 device after activating the Command mode in byte 0 (control bit 0.0), set the corresponding bit in byte 2.

The Leuze end device also responds to most commands by sending data, such as the bar code contents, NoRead, device version, etc., back to the gateway. The answer is not evaluated by the gateway, but is instead passed on to the PLC.

For the BPS 8, BPS 300i and hand-held scanners, a number of specific features are to be noted.



Notice!

Please note that Leuze only assumes liability for the function of Leuze products. When using third-party devices, Leuze does not assume liability for the function of third-party devices!

16.1 Standard setting, KONTURflex (S4 switch position 0)

This switch position can be used with almost all devices, since a data frame is transmitted along with it if necessary. A 00h in the data range of the control is interpreted as the end of a telegram/invalid, however.

The distance between two successive telegrams (without frame) must be more than 20ms in this switch position, since there is otherwise no clear separation between them. If necessary, the settings have to be adjusted on the device.

Leuze measuring sensors with RS 232 interface (such as a KONTURflex Quattro RS) do not necessarily use a telegram frame, which is why these are also operated in switch position 0.

Specifications for the serial interface

Default parameter	Standard
Baud rate	9600
Data mode	8N1
Handshake	no
Protocol	framing protocol without acknowledgment
Frame	<Data>
Data Mode	transparent



Notice!

The data frame is specified via the switch position. In the factory setting, the S4 switch position is 0. Resetting the settings to these is possible in S4 switch position F. The procedure for doing this is described in chapter 16.13.

KONTURflex specifications

Settings on the MA 238*i*

- EtherCAT address is freely selectable
- Device selection switch at position "0"

EtherCAT settings

- Module selection:
Dependent on number of beams used, but at least "8 bytes In"
- User parameters:
"Transparent Mode", "Use software settings", baud rate 38400, "8 Data Bits",
"No parity", "2 stop bits"

KONTURflex settings

First, the following settings are to be performed on the device using KONTURFlex-Soft:

- Either "Autosend (fast)" or "Autosend with data in Modbus format"
- Repeat time "31.5ms"
- Autosend baud rate "38.4KB"
- 2 stop bits, no parity

16.2 Bar code reader BCL 8 (S4 switch position 1)

Specifications for the serial interface

Default parameter	BCL 8
Baud rate	9600
Data mode	8N1
Handshake	no
Protocol	framing protocol without acknowledgment
Frame	<STX> <Data> <CR> <LF>

Specifications for Command mode

To activate the Command mode, bit 0 must be set to 1 in control byte 0.

For further information, see chapter 11.1.3 "Command mode", figure 11.2.

Control bit	Meaning	Corresponds to serial command (ASCII)
0	Version query	v
1	Activation / deactivation reading gate	+ / -
2	Reference-code 1 teach-in	RT1
3	Reference-code 2 teach-in	RT2
4	Automatic configuration of reading task activation / deactivation	CA+ / CA-
5	Switching output 1 activation	OA1
6		
7	Switching output 1 deactivation	OD1
8	System standby	SOS
9	System active	SON
10	Query reflector polling	AR?
11	Output version of the boot kernel with check sum	VB
12	Output version of the decoder program with check sum	VK
13	Reset parameters to default values	PC20
14	Device restart	H

Recommended settings

- Input data: dependent on the number of digits of the bar code that is to be read.

With an 18-digit bar code (+ 2 bytes of status bytes), for example, it is advisable to use the 24-byte setting.
- Output data: 8 bytes

16.3 Bar code reader BCL 22 (S4 switch position 2)

Specifications for the serial interface

Default parameter	BCL 22
Baud rate	9600
Data mode	8N1
Handshake	no
Protocol	framing protocol without acknowledgment
Frame	<STX> <Data> <CR> <LF>

Specifications for Command mode

To activate the Command mode, bit 0 must be set to 1 in control byte 0.

For further information, see chapter 11.1.3 "Command mode", figure 11.2.

Control bit	Meaning	Corresponds to serial command (ASCII)
0	Version query	v
1	Activation / deactivation reading gate	+ / -
2	Reference-code 1 teach-in	RT1
3	Reference-code 2 teach-in	RT2
4	Automatic configuration of reading task activation / deactivation	CA+ / CA-
5	Switching output 1 activation	OA1
6	Switching output 2 activation	OA2
7	Switching output 1 deactivation	OD1
8	Switching output 2 deactivation	OD2
9		
10		
11	Output version of the boot kernel with check sum	VB
12	Output version of the decoder program with check sum	VK
13	Reset parameters to default values	PC20
14	Device restart	H
15		

Recommended settings

- Input data: dependent on the number of digits of the bar code that is to be read.

With an 18-digit bar code (+ 2 bytes of status bytes), for example, it is advisable to use the 24-byte setting.

- Output data: 8 bytes

16.4 Bar code reader BCL 300i, BCL 500i, BCL 600i (S4 switch position 4)

Specifications for the serial interface

Default parameter	BCL 300i, BCL 500i, BCL 600i
Baud rate	9600
Data mode	8N1
Handshake	no
Protocol	framing protocol without acknowledgment
Frame	<STX> <Data> <CR> <LF>

Specifications for Command mode

To activate the Command mode, bit 0 must be set to 1 in control byte 0.

For further information, see chapter 11.1.3 "Command mode", figure 11.2.

Control bit	Meaning	Corresponds to serial command (ASCII)
0	Version query	v
1	Activation / deactivation reading gate	+ / -
2	Reference code teach-in activation / deactivation	RT+ / RT-
3		
4	Autom. configuration of reading task activation / deact.	CA+ / CA-
5	Switching output 1 activation	OA1
6	Switching output 2 activation	OA2
7	Switching output 1 deactivation	OD1
8	Switching output 2 deactivation	OD2
9		
10		
11		
12		
13	Parameter - difference to default parameter set	PD20
14	Reset parameters to default values	PC20
15	Device restart	H

Recommended settings

- Input data: dependent on the number of digits of the bar code that is to be read.
 With an 18-digit bar code (+ 2 bytes of status bytes), for example, it is advisable to use the 24-byte setting.
- Output data: 8 bytes

16.5 Bar code reader BCL 90, BCL 900i (S4 switch position 5)

Specifications for the serial interface

Default parameter	BCL 90, BCL 900i
Baud rate	9600
Data mode	8N1
Handshake	no
Protocol	framing protocol without acknowledgment
Frame	<STX> <Data> <CR> <LF>

Specifications for Command mode

To activate the Command mode, bit 0 must be set to 1 in control byte 0.

For further information, see chapter 11.1.3 "Command mode", figure 11.2.

Control bit	Meaning	Corresponds to serial command (ASCII)
0	Version query	v
1	Activation / deactivation reading gate	+ / -
2	Configuration mode	11
3	Alignment mode	12
4	Read operation	13
5		
6		
7		
8		
9		
10		
11		
12		
13		
14	Reset parameters to default values	PC20
15	Device restart	H

Recommended settings

- Input data: dependent on the number of digits of the bar code that is to be read.

With an 18-digit bar code (+ 2 bytes of status bytes), for example, it is advisable to use the 24-byte setting.

- Output data: 8 bytes



Notice!

When using the command mode, make sure that 00H is shown in the data range; otherwise the device only performs one alignment cycle.

16.6 LSIS 122, LSIS 222 (S4 switch position 6)

Specifications for the serial interface

Default parameter	LSIS 122, LSIS 222
Baud rate	9600
Data mode	8N1
Handshake	no
Protocol	framing protocol without acknowledgment
Frame	<STX> <Data> <CR> <LF>

Specifications for Command mode

To activate the Command mode, bit 0 must be set to 1 in control byte 0.

For further information, see chapter 11.1.3 "Command mode", figure 11.2.

Control bit	Meaning	Corresponds to serial command (ASCII)
0	Version query	i
1	Activation/Deactivation of reading gate: 12h/14h (LSIS 122 only)	<DC2> / <DC4>
2	Activation of reading gate (LSIS 222 only)	<SYN>T<CR>
3	Deactivation of reading gate (LSIS 222 only)	<SYN>U<CR>
4		
5		
6		
7		
8		
9		
10		
11		
12		
13		
14		
15		

Recommended settings

- Input data: dependent on the number of digits of the code that is to be read.

With an 18-digit code (+ 2 bytes of status bytes), for example, it is advisable to use the 24-byte setting.

- Output data: 8 bytes

16.7 LSIS 4x2i, DCR 202i (S4 switch position 7)

Specifications for the serial interface

Default parameter	LSIS 4x2i, DCR 202i
Baud rate	9600
Data mode	8N1
Handshake	no
Protocol	framing protocol without acknowledgment
Frame	<STX> <Data> <CR> <LF>

Specifications for Command mode

To activate the Command mode, bit 0 must be set to 1 in control byte 0.

For further information, see chapter 11.1.3 "Command mode", figure 11.2.

Control bit	Meaning	Corresponds to serial command (ASCII)
0	Version query	v
1	Image acquisition trigger	+
2		
3		
4		
5		
6		
7		
8		
9		
10		
11		
12		
13		
14		
15		

Recommended settings

- Input data: dependent on the number of digits of the code that is to be read.

With an 18-digit code (+ 2 bytes of status bytes), for example, it is advisable to use the 24-byte setting.

- Output data: 8 bytes

16.8 Hand-held scanner (S4 switch position 8)

Specifications for the serial interface

Default parameter	Hand-held scanner
Baud rate	9600
Data mode	8N1
Handshake	no
Protocol	framing protocol without acknowledgment
Frame	<Data> <CR> <LF>



Notice!

Command mode cannot be used with hand-held scanners.

Recommended settings

- Input data: dependent on the number of digits of the bar code or 2D code that is to be read.

With an 12-digit code (+ 2 bytes of status bytes), for example, it is advisable to use the 16-byte setting.
- Output data: none

16.9 RFI, RFM, RFU RFID readers (S4 switch position 9)

Specifications for the serial interface

Default parameter	RFM 12,RFM 32 and RFM 62 RFI 32 RFU (via IMRFU)
Baud rate	9600
Data mode	8N1
Handshake	no
Protocol	framing protocol without acknowledgment
Frame	<STX> <Data> <CR> <LF>

Specifications for Command mode

To activate the Command mode, bit 0 must be set to 1 in control byte 0.

For further information, see chapter 11.1.3 "Command mode", figure 11.2.

Control bit	Meaning	Corresponds to serial command (ASCII)
0	Version query	v ¹⁾
1	Activation / deactivation reading gate	+ / -
2		
3		
4		
5		
6		
7		
8		
9		
10		
11		
12		
13		
14	Reset parameters to default values	R ¹⁾
15	Device restart	H

1) Not for IMRFU/RFU

Recommended settings

- Input data: dependent on the number of digits of the RFID code that is to be read.

For example, it is advisable to use the input data/output data setting with 24 bytes during the reading of a serial number with 16 characters (+ 2 bytes of status bytes).

- Output data: 8 bytes

The RFID devices expect the telegrams / data in HEX format.

16.10 BPS 8 bar code positioning system (S4 switch position A)

Specifications for the serial interface

Default parameter	BPS 8
Baud rate	57600
Data mode	8N1
Handshake	no
Protocol	binary protocol without acknowledgment
Frame	<Data>

Specifications for Command mode

To activate the Command mode, bit 0 must be set to 1 in control byte 0.

For further information, see chapter 11.1.3 "Command mode", figure 11.2.

Control bit	Meaning	Corresponds to serial command (HEX)	
		byte 1	byte 2
0	Request diagnostic info	01	01
1	Request marker info	02	02
2	Request SLEEP mode	04	04
3	Request position info	08	08
4	Request individual measurement	10	10
5			
6			
7			
8			
9			
10			
11			
12			
13			
14			
15			

Recommended settings

- Input data: 8 bytes
- Output data: 8 bytes

In this switch position, the MA automatically sends a position request to the BPS 8 every 10ms until another command comes via the control. Automatic request only restarts when a new position request is sent by the PLC or when the MA is restarted.

16.11 BPS 300i bar code positioning system, ODSL xx optical distance sensors with RS 232 interface (S4 switch position B)



Notice!

In this switch position, 6-byte data (fixed) is always expected by the device. This is why a quick telegram sequence can be transmitted reliably even without a data frame.

BPS 300i

Specifications for the serial interface

Default parameter	BPS 300i
Baud rate	38400
Data mode	8N1
Handshake	no
Protocol	binary protocol without acknowledgment
Frame	<Data>

Specifications for Command mode

To activate the Command mode, bit 0 must be set to 1 in control byte 0.

For further information, see chapter 11.1.3 "Command mode", figure 11.2.

Control bit	Meaning	Corresponds to serial command (ASCII)
0	Transmit individual position value = single shot	COF131
1	Cyclically transmit position values	COF232
2	Stop cyclical transmission	COF333
3	Laser diode on	COF434
4	Laser diode off	COF535
5	Transmit single speed value	COF636
6	Cyclically transmit speed values	COF737
7	Transmit single position and speed value	COF838
8	Cyclically transmit position and speed values	COF939
9	Transmit marker information	COFA3A
10	Not used / reserved	
11	Transmit diagnostic information	COFC3C
12	Activate standby	COFD3D
13		
14		
15		

Recommended settings

- Input data: 8 bytes
- Output data: 8 bytes

ODSL 9, ODSL 30 and ODSL 96B



Notice!

The default settings of the ODS serial interface have to be adjusted! Further information on configuration of the interface can be found in the technical description of the corresponding device.

Specifications for the serial interface

Default parameter	ODSL xx
Baud rate	38400
Data mode	8N1
Handshake	no
Protocol	ASCII transmission, 5-digit measurement value
Frame	<Data>

Specifications for Command mode

Command mode cannot be used with the ODSL 9, ODSL 30 and ODSL 96B.

The ODSL 9/96B is to be operated in the "Precision" measure mode. The mode is set through the display menu via **Application -> Measure mode -> Precision**. You can find more details on this in the technical description.

16.12 Modular interfacing unit MA 3x (S4 switch position C)

Specifications for the serial interface

Default parameter	MA 3x
Baud rate	9600
Data mode	8N1
Handshake	no
Protocol	framing protocol without acknowledgment
Frame	<STX> <Data> <CR> <LF>

Specifications for Command mode

To activate the Command mode, bit 0 must be set to 1 in control byte 0.

For further information, see chapter 11.1.3 "Command mode", figure 11.2.

Control bit	Meaning	Corresponds to serial command (ASCII)
0	Version query	v
1		
2		
3		
4		
5		
6		
7		
8		
9		
10		
11		
12		
13		
14	Reset parameters to default values	PC20
15	Device restart	H

Recommended settings

- Input data: dependent on the number of digits of the code that is to be read.

With an 18-digit bar code (+ 2 bytes of status bytes + 2 bytes of slave address), for example, it is advisable to use the 24-byte setting.

- Output data: 8 bytes



Notice!

In this switch position, the address of the multiNet slave is also transmitted in the first two bytes of the data range!

16.13 Resetting the parameters (S4 switch position F)

To reset all parameters of the MA that can be configured with software (such as baud rate, IP address, dependent on type) to the factory settings, do the following:

- ↳ *Set device switch S4 to F in a voltage free state.*
- ↳ *Switch the voltage on and wait until it is ready for operation.*
- ↳ *If necessary, switch the voltage off to prepare for commissioning.*
- ↳ *Set service switch S10 to the "RUN" position.*

17 Appendix

17.1 ASCII Table

HEX	DEC	CTRL	ABB	DESIGNATION	MEANING
00	0	^@	NUL	NULL	Zero
01	1	^A	SOH	START OF HEADING	Start of heading
02	2	^B	STX	START OF TEXT	Start of text characters
03	3	^C	ETX	END OF TEXT	Last character of text
04	4	^D	EOT	END OF TRANSMISSION	End of transmission
05	5	^E	ENQ	ENQUIRY	Request to transmit data
06	6	^F	ACK	ACKNOWLEDGE	Positive acknowledgment
07	7	^G	BEL	BELL	Bell signal
08	8	^H	BS	BACKSPACE	Backspace
09	9	^I	HT	HORIZONTAL TABULATOR	Horizontal tabulator
0A	10	^J	LF	LINE FEED	Line feed
0B	11	^K	VT	VERTICAL TABULATOR	Vertical tabulator
0C	12	^L	FF	FORM FEED	Form feed
0D	13	^M	CR	CARRIAGE RETURN	Carriage return
0E	14	^N	SO	SHIFT OUT	Shift out
0F	15	^O	SI	SHIFT IN	Shift in
10	16	^P	DLE	DATA LINK ESCAPE	Data link escape
11	17	^Q	DC1	DEVICE CONTROL 1 (X-ON)	Device control character 1
12	18	^R	DC2	DEVICE CONTROL 2 (TAPE)	Device control character 2
13	19	^S	DC3	DEVICE CONTROL 3 (X-OFF)	Device control character 3
14	20	^T	DC4	DEVICE CONTROL 4	Device control character 4
15	21	^U	NAK	NEGATIVE (/Tape) ACKNOWLEDGE	Negative acknowledge
16	22	^V	SYN	SYNCHRONOUS IDLE	Synchronization
17	23	^W	ETB	END OF TRANSMISSION BLOCK	End of data transmission block
18	24	^X	CAN	CANCEL	Invalid
19	25	^Y	EM	END OF MEDIUM	End of medium
1A	26	^Z	SUB	SUBSTITUTE	Substitution
1B	27	^[ESC	ESCAPE	Escape
1C	28	^\ ^	FS	FILE SEPARATOR	File separator
1D	29	^] ^]	GS	GROUP SEPARATOR	Group separator
1E	30	^^ ^^	RS	RECORD SEPARATOR	Record separator
1F	31	^_ ^_	US	UNIT SEPARATOR	Unit separator
20	32		SP	SPACE	Space
21	33	!	!	EXCLAMATION POINT	Exclamation point
22	34	"	"	QUOTATION MARK	Quotation mark
23	35	#	#	NUMBER SIGN	Number sign
24	36	\$	\$	DOLLAR SIGN	Dollar sign
25	37	%	%	PERCENT SIGN	Percent sign
26	38	&	&	AMPERSAND	Ampersand
27	39	'	'	APOSTROPHE	Apostrophe
28	40	((OPENING PARENTHESIS	Opening parenthesis

HEX	DEC	CTRL	ABB	DESIGNATION	MEANING
29	41)	CLOSING PARENTHESIS	Closing parenthesis
2A	42		*	ASTERISK	Asterisk
2B	43		+	PLUS	Plus sign
2C	44		,	COMMA	Comma
2D	45		-	HYPHEN (MINUS)	Hyphen (minus)
2E	46		.	PERIOD (DECIMAL)	Period (decimal)
2F	47		/	SLANT	Slant
30	48		0		
31	49		1		
32	50		2		
33	51		3		
34	52		4		
35	53		5		
36	54		6		
37	55		7		
38	56		8		
39	57		9		
3A	58		:	COLON	Colon
3B	59		;	SEMICOLON	Semicolon
3C	60		<	LESS THAN	Less than
3D	61		=	EQUALS	Equals
3E	62		>	GREATER THAN	Greater than
3F	63		?	QUESTION MARK	Question mark
40	64		@	COMMERCIAL AT	Commercial AT
41	65		A		
42	66		B		
43	67		C		
44	68		D		
45	69		E		
46	70		F		
47	71		G		
48	72		H		
49	73		I		
4A	74		J		
4B	75		K		
4C	76		L		
4D	77		M		
4E	78		N		
4F	79		O		
50	80		P		
51	81		Q		
52	82		R		
53	83		S		
54	84		T		
55	85		U		
56	86		V		
57	87		W		
58	88		X		

HEX	DEC	CTRL	ABB	DESIGNATION	MEANING
59	89		Y		
5A	90		Z		
5B	91		[OPENING BRACKET	Opening bracket
5C	92		\	REVERSE SLANT	Reverse slant
5D	93]	CLOSING BRACKET	Closing bracket
5E	94		^	CIRCUMFLEX	Circumflex
5F	95		_	UNDERSCORE	Underscore
60	96		`	GRAVE ACCENT	Grave accent
61	97		a		
62	98		b		
63	99		c		
64	100		d		
65	101		e		
66	102		f		
67	103		g		
68	104		h		
69	105		i		
6A	106		j		
6B	107		k		
6C	108		l		
6D	109		m		
6E	110		n		
6F	111		o		
70	112		p		
71	113		q		
72	114		r		
73	115		s		
74	116		t		
75	117		u		
76	118		v		
77	119		w		
78	120		x		
79	121		y		
7A	122		z		
7B	123		{	OPENING BRACE	Opening brace
7C	124			VERTICAL LINE	Vertical line
7D	125		}	CLOSING BRACE	Closing brace
7E	126		~	TILDE	Tilde
7F	127		DEL	DELETE (RUBOUT)	Delete

A

Accessories 71
 Bus connection cables 73
 Cables for Leuze ident devices 75
 Connector 71
 Voltage supply cables 72
 ASCII Table 92

C

Causes of errors
 General 69
 Interface 70
 Collective mode 13
 Command mode 13, 55
 Commissioning 58
 Configuration 39, 58
 Connecting the Leuze device 11
 PCB connectors X30 ... X32 37
 Connections
 PWR IN 25
 PWR OUT switching input/output 27
 Control bytes 47

D

Declaration of Conformity 5
 Definition of terms 7
 Description of functions 6
 Device description 13
 Device interface RS 232 30
 Diagnosis 69
 Dimensioned drawings 19
 Disassembling 76
 Disposing 76

E

Electrical connection 10
 Connecting the Leuze device 11
 Power supply and bus cable 11, 59
 Safety notices 24
 EtherCAT
 Cable lengths and shielding 32
 Ethernet connection cable 73

F

Fast commissioning 10
 Fieldbus systems 16

I

Input byte 0
 Buffer overflow 46
 Data exist 45
 Data loss 46
 New data 47
 Next block ready to transmit 46
 Service mode active 45
 Write-Acknowledge 45
 Input byte 1
 Data length code 47
 Interface
 EtherNet/IP 30

L

LED status indicators 33
 Leuze device
 2D-code reader
 DCR 202i 84
 LSIS 122 83
 LSIS 222 83
 LSIS 4x2i 84
 Bar code positioning system (BPS)
 BPS 300i 88
 BPS 8 87
 Bar code reader (BCL)
 BCL 22 80
 BCL 300i 81
 BCL 500i 81
 BCL 600i 81
 BCL 8 79
 BCL 90 82
 BCL 900i 82
 Hand-held scanner 85
 Optical distance sensor (ODSL) 88
 RFID read-write devices (RFM/RFI ...)
 RFM 12, 32 and 62 86
 Setting the read parameters 66
 Specific feature for hand-held scanners 67
 Specifications for Command mode 77
 Specifications for the serial interface 77

M

Maintenance 76
 Mounting
 Device arrangement, selecting a mounting location 10, 23

Mounting the device	10, 22	Output bytes	47
O		Transparent mode	13
Operating modes		Troubleshooting	69
Operation	15	Type overview	20, 71
Service fieldbus gateway	15	W	
Service Leuze device	15	Writing slave data	52
Output byte 0			
Address bits 0 .. 4	48		
Broadcast	48		
Command mode	48		
New data	48		
Output byte 1			
Copy to transmit buffer	50		
Read-Acknowledge	49		
Send data from buffer	49		
P			
Packing	76		
Q			
Quality assurance	5		
R			
Reading slave data	52		
Repair	76		
S			
Service interface	31, 37		
Service mode			
Commands	41		
Information	41		
Service switch	37		
Servicing	76		
Specifications	18		
Electrical data	18		
Environmental data	18		
Indicators	18		
Mechanical data	18		
Starting the device	11, 59		
Status bytes	44		
Structure of the fieldbus telegram	43		
Symbols	5		
T			
Telegram structure			
Input bytes	44		